



**INSTRUCTION MANUAL
FOR 60 SERIES BUILT-IN
OVEN 600SPYKT**



OPEN 24/7
ILVE ACCESSORIES ONLINE SHOP

For a wide range of coffee machines, pods, and other ILVE accessories at the click of a button shop.ilve.com.au

TABLE OF CONTENTS

SAFETY INSTRUCTIONS	2	Eco-Bake	15
INSTALLATION OF THE OVEN	4	Defrost	15
Electricals	4	Pyrolyse (Self-Clean)	15
Respect for the environment	5	Door lock for children safety (pyro)	16
Connection to the electrical power mains	7	Commands lock for children safety (non pyro)	16
INSTRUCTIONS FOR USE	8	Buzzer volume	16
The first time you use the oven	8	Failure declarations and error codes	16
Oven Racks	8	DOOR LOCKING SYSTEM	18
Removable Guides	8	CLEANING AND MAINTENANCE	19
COOKING FUNCTIONS	9	Self-cleaning cycle (pyrolytic cycles)	19
ELECTRONIC CONTROL	11	Removing the "FULL GLASS" panoramic door	20
Power-up	11	How to remove the inner glass of the "FULL GLASS" panoramic door	21
Programming time functions	11	Replacement of the oven light	23
Setting the time of day	11	GUIDANCE TEMPERATURE AND TIME SCHEDULE FOR COOKING	24
Setting the minute minder	12		
Setting an oven function manually	13		
Setting an automatic oven function	13		
Oven functions	14		

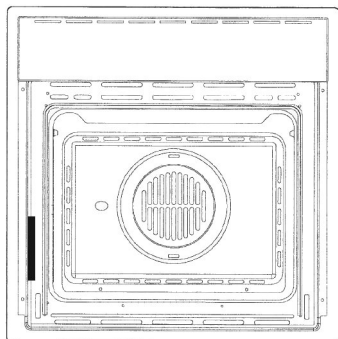

IMPORTANT

The oven's data plate is accessible even with the oven fully installed. The plate is visible simply by opening the door. Always quote the details from it to identify the appliance when ordering spare parts.

SAFETY INSTRUCTIONS

- **Do not disassemble any parts prior to having disconnected the oven from the mains.**
- **Do not use the appliance if any part is broken (for example a glass). Disconnect it from the mains and call service.**
- Before using the oven, it is recommended to make it operate at no-load at the maximum temperature for an hour to eliminate the insulating material odour.
- In all models, leave the door closed when the grill is used.
- The cooling fan may remain in operation so long as the oven is hot, even after it has been switched off.
- **During the use the appliance becomes very hot; don't touch the heating elements inside the oven.**
- **During the oven operation, the front is heated as well; consequently keep children clear of the oven, especially during self-cleaning.**
- Parents and adults should pay particular attention when using the product in presence of children.
- Children should be overseen so as to ensure that they don't play with the equipment.
- **Keep children under age 8 away, unless constantly supervised.**
- This appliance is not intended for use by persons (including children over age 8) with reduced physical sensory or mental capabilities, or lack of experience and knowledge, unless they have been given supervision or instruction concerning use of the appliance by a person responsible for their safety.
- **Children may not perform cleaning and maintenance unsupervised.**
- In order to avoid damage to the oven enamel coat, do not cover the oven muffle sole with any item (e.g. aluminum foil, pans and the likes).
- Do not use harsh abrasive cleaners or sharp metal scrapers to clean the oven door glass since they can scratch the surface, which may result in shattering of the glass.
- Abrasive detergents and steam cleaning equipment should not be used for cleaning.
- Before performing self-cleaning, take out all accessories (grills, dishes, pans) to avoid damaging them, remove large cooking residues and then close the door, ensuring that it is closed properly.
- The oven is cool and power to the oven has been turned off before removing the door. Failure to do so could result in electrical shock or burns.
- The appliance must not be installed behind a decorative door in order to avoid overheating.
- **WARNING: Ensure that the appliance is switched off before replacing the lamp to avoid the possibility of electric shock.**

Refer to the figures below for the correct placement of the grills
EMBOSSED GUIDES

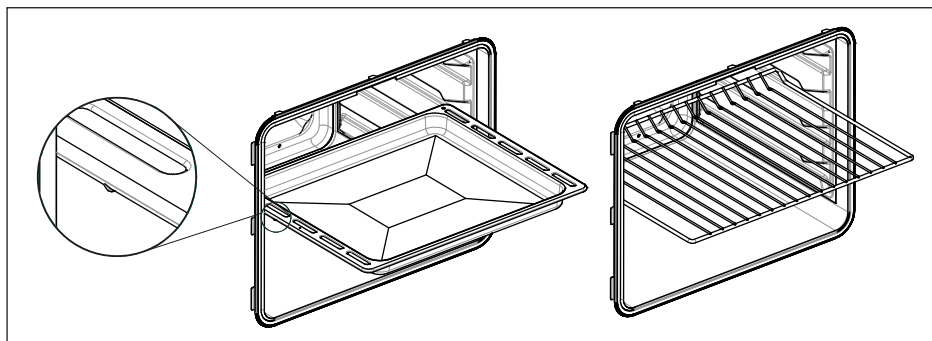

REMOVABLE GUIDES

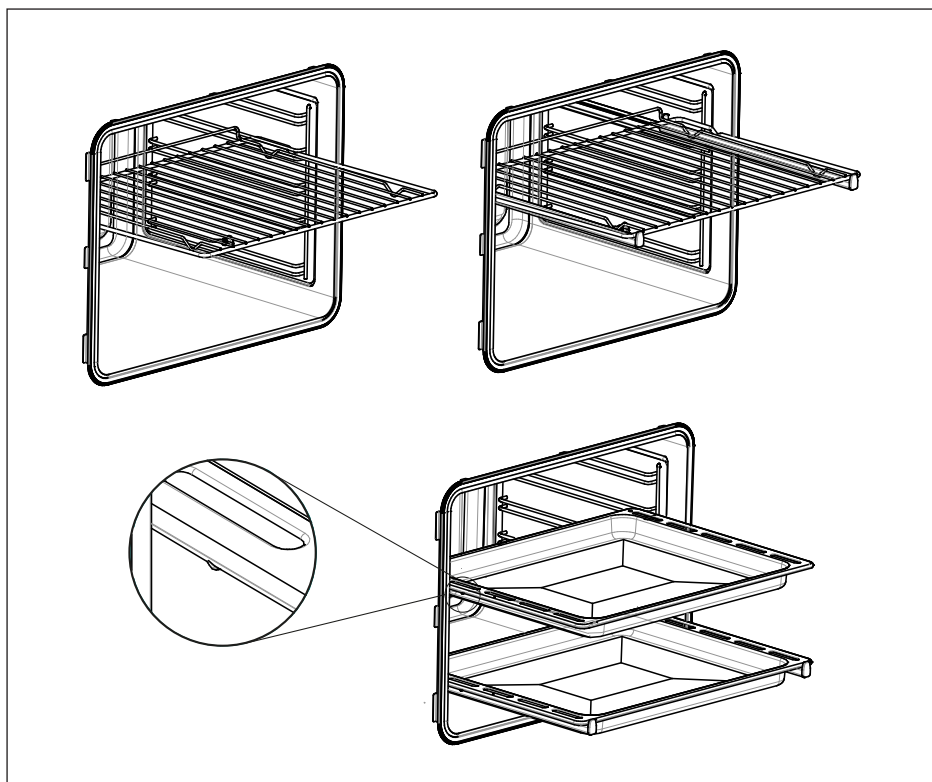

INSTALLATION OF THE OVEN

To install the oven into the kitchen a cutout should be made in accordance with the dimensions shown in figure.

The apparatus is to be fastened to the top by means of the two screws provided in the kit through the holes made on the oven uprights.

The cabinet in which the apparatus is installed shall be open on the back side to ensure a sufficient air circulation and prevent overheating.

Leave a gap of at least 200 cm² (see Fig. 1) for air circulation if the oven is installed in a column; this is not necessary if the oven is installed under the work top.

WARNING

As the apparatus is to be fitted in your kitchen furniture, make sure that all surfaces in contact with the oven can resist a temperature of approx 90°C.

Electricals

- Absorbed power:

oven top element:.....	1200+1000W 230V - 1200+1000W 240V
oven bottom element:	1100W 230V - 1100W 240V
round element (hot air):	2300W 230V - 2300W 240V
	(on some models)
roasting jack motor:	4 W (on some models)
lamp:	25 W
hot air fan motor:.....	25 W
cooling fan motor:.....	25 W

- Maximum absorbed power: (see data plate).

- Supply voltage: (see data plate).

NOTE

This appliance is in compliance with following European directives: 2006/95/CE (LVD), 2004/108/CE (EMC), 2011/65/CE (RoHS), 2012/19/UE (WEEE), 2002/40/CE.

Respect for the environment

The documentation for this appliance is printed on paper bleached without chlorine or recycled paper to contribute to protecting the environment. The packaging was designed to prevent damage to the environment; they are ecological products that can be recovered or recycled.

Recycling the packing saves raw materials and reduces the volume of industrial and domestic waste.



THE PACKING MATERIAL is 100% recyclable and marked with the recycling symbol. Dispose of in conformity with local law. The packing material (plastic bags, polystyrene parts, etc.) must be kept out of the reach of children because it is potentially dangerous. THIS APPLIANCE is marked in conformity with European Directive 2012/96/UE, Waste Electrical and Electronic Equipment (WEEE). By making sure that this product is disposed of correctly, the user contributes to preventing potential negative consequences for the environment and health.

THE SYMBOL on the product or accompanying documentation indicates that this product must not be treated as domestic waste but must be delivered to a suitable collection point for the recycling of electrical and electronic equipment.



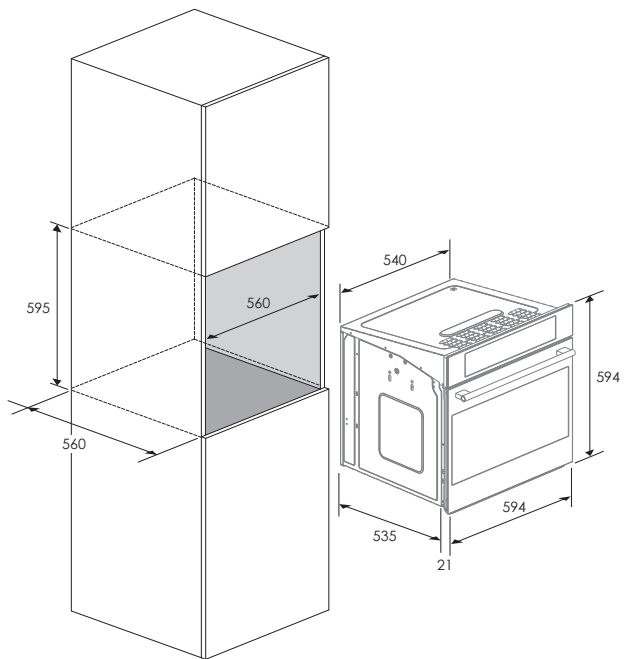
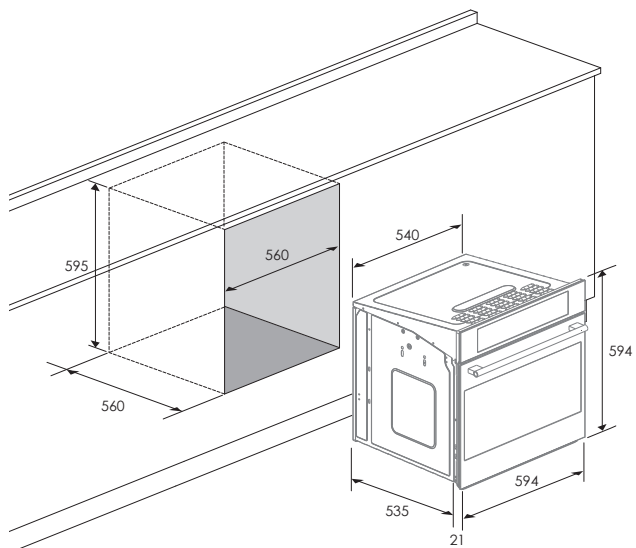

Dimensions are in millimeters

Connection to the electrical power mains

WARNING

This apparatus must be earthed.

The oven is only for domestic use.

The feed voltage and the absorbed power are as indicated on the data plate attached to the left-hand side upright, which can be seen when the oven door is open.

Connecting must be carried out by qualified personnel and in accordance with the regulations currently in force.

The manufacturer can not be held responsible for any damages to persons or objects caused by failure to observe these instructions.

If the supply cord is damaged, it must be replaced by the manufacturer, its service agent or similarly qualified persons in order to avoid a hazard.

The oven must be connected to the mains through a multipole circuit breaker with a contact-to-contact gap of at least 3 mm, making sure that the earth wire is not disconnected. For connecting use a flexible cable remembering to make it long enough to allow the oven to be removed from its housing unit when maintenance work is required.

CABLE TYPES AND MINIMAL DIAMETERS	
	SASO
H05RR-F 3x1,5 mm ²	H05RR-F 3x2,5 mm ²
H05VV-F 3x1,5 mm ²	H05VV-F 3x2,5 mm ²
H05RN-F 3x1,5 mm ²	H05RN-F 3x2,5 mm ²
H05V2V2-F 3x1,5 mm ²	H05V2V2-F 3x2,5 mm ²

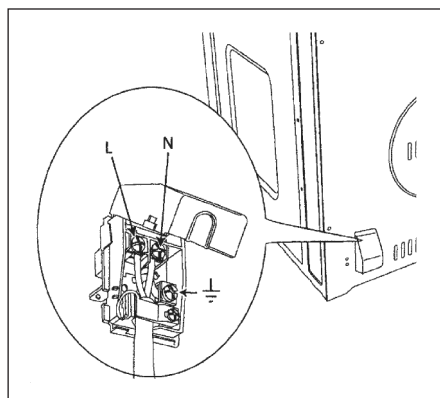

INSTRUCTIONS FOR USE

The first time you use the oven

Clean the oven thoroughly with soapy water and rinse well. Operate the oven for about 30 minutes at maximum temperature to burn off all traces of grease which might otherwise create unpleasant smells when cooking.

Oven Racks

WARNING

Never use aluminum foil to cover the oven racks or to line the oven. It can cause damage to the oven liner if heat is trapped under the foil.

WARNING

Make sure you do not force it to avoid damage to the enamel.

The oven has rack guides at four levels. Rack positions are numbered from the bottom rack guide (#1) to the top (#4).

Check cooking charts for best rack positions to use when cooking.

Always be sure to position the oven racks before turning on the oven. Make sure that the racks are level once they are in position.

The racks are designed to stop when pulled forward to their limit.

Removable Guides

NOTE





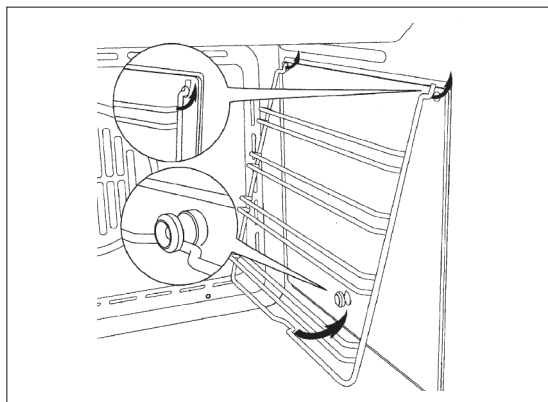

Always remove the removable guides before oven self-cleaning.

To remove the lateral frames from smooth-walled ovens, proceed as shown in the figure.



COOKING FUNCTIONS

Each type of oven is provided for various cooking systems. A system can be selected by bringing the pointer of knob to the relating symbol. The Fig. 8 shows the controls available on the different oven models.

Icon	Mode Description	Used for...
0	All the cooking modes are OFF and the oven heating elements are OFF.	---
	The light is on only.	---
	In this mode only the internal oven convection fan is ON i.e. there is no oven heating	This mode is used to defrost deepfrozen food.
	In this mode only the smaller bottom heating element is on.	This mode is used to keep foods warm.
	In this mode both upper (top) and lower (bottom) oven heating elements are used to heat the oven air. However, no fan is used to circulate the heat.	This is the traditional mode of cooking on one shelf. Therefore only one rack can be used when selecting the Bake mode. Ideal for Appetizers, Biscuits, Coffee Cakes and Cookies.
	This mode is intended to save energy. In particular the oven cooling fan works only when needed e.g. when the oven is hot and the electronics require cooling.	Ideal for frozen or precooked food, and small portions-meals. The preheat time is very short and cooking tends to be slower. It is not recommended for heavy loads e.g. large portions or big meal preparation.
	Only the lower (bottom) oven heating element is activated.	Used to complete cooking.
	The Convection Roast mode uses the upper (top) oven heating element, the lower (bottom) heating element and the convection fan inside the oven.	Ideal for the roasting of whole chickens or turkey and pizza. It can also be used for baking-cooking Appetizers, Biscuits, Coffee Cakes and Cookies on one or more levels.



The Convection Bake mode uses the circular or third heating element hidden behind the baffle at the back wall of the oven. The heat is circulated throughout the oven by the convection fan.

Consequently different foods can be cooked simultaneously (maximum three levels) and is suitable for preparing a complete dinner (small portions). Mixing of flavours is avoided and an important energy saving is obtained.



The Convection Down mode uses the lower (Bottom) heating element and internal fan.

Useful for soufflés, pizzas and pastry dishes.



suitable for preparing a complete dinner (small portions). Mixing of flavours is avoided and an important energy saving is obtained.

Ideal for steak, hamburgers, chicken quarters or chicken breasts.



The Grill mode uses intense heat radiated from the upper (top) heating element.

Ideal for preparing toast, browning and grilling.



If the spit device is fitted it is also used with the spit motor.

If the spit motor is fitted the spit roasting of a whole chicken or turkey is possible.



The standard time is 1.30 h and can be changed. (see page 16)

PYRO or self-cleaning mode. Here the oven is automatically cleaned by burning-off cooking residues at high temperature (about 475 °C) from 1h to 3h. During the self-cleaning cycle all fumes produced are filtered and then expelled to ambient.

ELECTRONIC CONTROL

Control panel description (“EXTRA SMALL”)

The oven control panel is made with one display and two knobs.

- Time & Temperature display.
- Time & Temperature knob (Push & Shuttle).
- Mode (oven functions) knob.

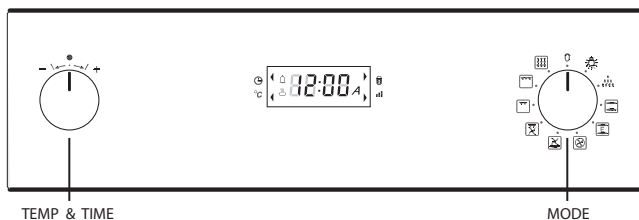

The push & shuttle knob is mainly for clock or temperature setting and automatic time functions programming. Select the desired item by pushing the knob.

Power-up

At every power-up, in pyrolytic ovens, the latch mechanism runs an automatic self-test: the oven door locks and unlocks. This operation takes about half a minute. The lock led turns on and flash while the action is in progress, it remains steadily displayed when the door is fully locked, it's off when the door has been unlocked.

Do not try to open the door until the lock led disappears.

Programming time functions

At every power-up, the control shows the time of day blinking, set at 12:00 as the initial value. The time increases every minute. The only possible action is the “Clock Regulation”, all other oven operations are inhibited.

In general, turn the Temp/Time selector left or right in order to edit the values and modify them by steps; hold the knob on the left or right to fasten the decrease/increase operations.

Setting the time of day

The time of day is always displayed in the 24 hours format. Hours and minutes are set separately. In order to set the time of day, mode selector must be in ZERO position, the -/+ knob acts on the time of day by default.

- Turn the selector left/right, the hours flash.
- Modify the flashing hours value turning the selector left/right.
- Push the Temp&Time selector to switch back and forth between hours and minutes.
- Modify the flashing minutes turning left/right.
- After a few seconds the whole time of day value starts flashing: wait until the new time of day is steady.

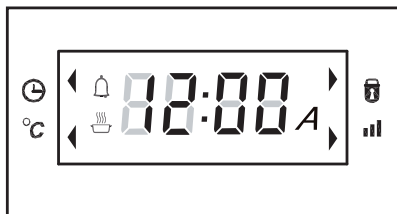

Push the knob to toggle between the time of day and the minute minder and check the set values. The clock is selected by default while the  symbol appears when the minute minder is displayed.

Setting the minute minder

When the  symbol is displayed, turn the knob left/right in order to set the timer value. The standard value is 30 minutes, it's possible to modify it in the range between 0 and 240 minutes.

This timer has no influence on the oven activities and can be set also when the oven is off. The time of day is displayed with priority in any case, the  symbol shows the minute minder is active.

When the time expires, the  symbol flashes and the buzzer sounds a warning sequence (two short beeps repeated every 3 seconds) to recall the user attention. Push the knob to stop it. The buzzer stops in any case after a time-out.

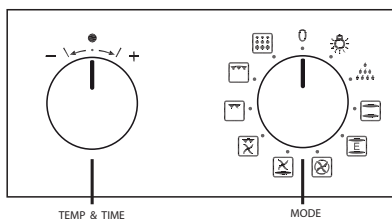

Setting an oven function manually

Turn the mode knob into the desired position, the clock display shows On for a few seconds. The oven will work for a maximum time (12hours). Depending on the oven model, the number and type of available functions can be different.

If the selected function works using any heating elements, the  symbol is displayed (it doesn't appear in light and defrost position).

Turn the Temp & Time selector and set the desired oven temperature. The control offers a PRESET temperature per every cooking mode or a full range between MIN and MAX to be adjusted by hand. Check the value on the display after having selected the temperature.

The temperature appears on the clock display for about 5 seconds when the Time & Temp selector is pushed or when a new function has just been selected.

As soon as the oven starts, the preheat led (indicated by the bars) on the left side of the clock display starts flashing and becomes steadily on when the preheat ends.

Turn the mode selector to ZERO (OFF) position to stop any activity, the display will show OFF for a few seconds.

Setting an automatic oven function

After having selected a function as described before, the control can be programmed in order to set timed cooking activities. The time program remains active even if the function is changed (exception: pyrolyse). The following possibilities are available:

- 1 Timed cooking setting the cooking time (duration).
- 2 Timed cooking setting the end of cooking time (stop time).
- 3 Delayed cooking setting duration and stop time.

Push the knob in order to toggle between cooking duration (cook time) and end of cooking time (stop time): the words "dur" or "End" are displayed respectively. Turn the knob left/right to edit the duration or the stop time when the proper word is displayed:

1. When the word dur is displayed, the control shows 30' as the standard cooking duration. Turn the knob left/right in order to set the actually desired cooking time in a range between 0 and 240 minutes. The display will flash dur and its value alternatively for a few seconds then it will show the time of day, the pot symbol and the **A** letter to indicate that a timed cooking is active. The end of cooking time is updated automatically.
2. When the word End is displayed, the control shows the current time as the initial stop time. In order to set the actually desired end of cooking time in a 24 hours range:

- Turn the knob left/right, the hours flash.
- Modify the flashing hours value turning the knob left/right.
- Push the knob to switch back and forth between hours and minutes or wait a few seconds until the minutes flash.
- Modify the flashing minutes value the knob left/right.
- Wait until the new End of Cooking time value stops flashing.

The display will flash End and its value alternatively for a few seconds then it will show the time of day, the  symbol and the **A** letter to indicate that a timed cooking is active. The cooking duration is updated automatically.

3. Repeat the same operations of point 1 then push the knob until End appears. the control shows the “current time + cooking time” as the initial stop time. It’s not possible to lower the end of cooking time below this value. In order to set the actually desired end of cooking time in a 24 hours range:

- Turn the knob left/right, the hours flash.
- Modify the flashing hours value turning the knob left/right.
- Push the knob to switch back and forth between hours and minutes or wait a few seconds until the minutes flash.
- Modify the flashing minutes value turning the knob left/right.
- Wait until the new End of Cooking time value stops flashing.

The display will flash End and its value alternatively for a few seconds then it will show the time of day and the **A** letter to indicate that a delayed cooking has been programmed. As soon as the delay time expires, the oven starts and works for the programmed cooking time. The  symbol is displayed.

At the end of any timed activity the control shuts down the oven, the buzzer sounds a warning sequence (two short beeps repeated every 3 seconds) to recall the user attention, for a maximum time and makes the time related icons (, **A**) flash on the display. Push the knob to silent the buzzer and reset the warning message.

Turn the mode selector to ZERO (OFF) position before reusing the oven.

Oven functions

The control can manage many cooking functions, here below described, their number and availability depends on the oven model. The temperature range is between 50°C and 250°C for most functions. Preset temperatures are mainly 190°C for convection modes, 210°C for thermal modes and 230°C for grilling functions.

Exceptions are Eco-Bake (preset=190°C), Pyrolyse (fixed 475°C), and low temperature modes (Light, Defrost, Keep Warm).

Eco-Bake

This function is defined in order to obtain a consistent energy saving. The cooling fan is initially off and turns on only when the inner parts temperature gets high. Cooking might be a little bit slower than the standard Bake, especially when the oven is heavily loaded.

Defrost

This function is used to defrost frozen food in a short time. It doesn't heat up the oven, only the convection fan works. The temperature display shows DEF to indicate that this special mode is active.

Pyrolyse (Self-Clean)

Turn the mode knob in the proper position to start a cleaning cycle. The temperature display show the writing **475°**.

The clean time can be set according to the same rules of the automatic functions, and therefore the pyrolytic cycle can be delayed.

The maximum allowed clean time is 3 hours, the minimum 1 hour. The standard time is 1h:30min, the clock display shows P1:30. At the end of the self-cleaning activity the display shows P--- steady and **A** flashing. The writings on the display disappear when the mode selector is placed in the ZERO position. The door remains locked until the oven temperature drops below the safety threshold, at this time the control unlocks the door.

The cooling fan starts as soon as the function is selected and turns to its higher speed when the inner parts get hot. The oven temperature is automatically set to 475°C in order to perfectly clean the cavity.

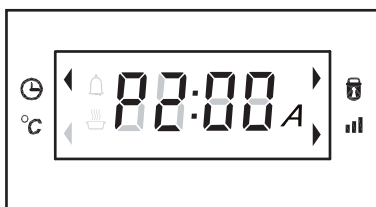

The control also locks immediately the door in order to guarantee the user safety, given that the temperature inside gets very hot. A lock led (yellow) beside the temperature display shows the status of the latch mechanism at any time:

- Door unlocked, lock led off.
- Door locked, lock led always on.
- Latch moving, transition in progress, lock led flashing.

To reuse the oven after a pyrolyse, turn the mode selector to ZERO (OFF) position.

Door lock for children safety (pyro)

This is an additional safety functions available only in pyrolytic ovens. The door latch mechanism that is managed automatically during pyrolyse can be actuated manually by the user in order to lock the oven door and prevent children from having free access to the oven.

Hold the Time&Temp knob for about 3 seconds to lock/unlock the door manually.

Commands lock for children safety (non pyro)

This is an additional safety functions available only in non pyrolytic ovens. Hold the Time&Temp knob for about 3 seconds to lock the control panel commands and prevent children from turning on the oven freely. Both knobs are disabled.

Buzzer volume

The buzzer volume can be set turning the Time&Temp knob left/right when the control is in light mode. At any detents the buzzer sounds a double beep, selecting the volume out of three available levels. The buzzer must always be silent between 22:00 and 8:00.

Failure declarations and error codes

The control is continuously checking the status of the system. If an abnormal condition is detected for more than 1 minute, a failure occurs:















- The heaters and the other loads are disabled.
- The display shows a “E” letter followed by a numeric code that depends on the kind of failure.
- The control emits an acoustic warning signal.

To reset a failure declaration, first remove the cause of the failure then turn the selector to (ZERO) OFF.

Error code table.

Error	Description
E1	Temperature sensor broken.
E2	Temperature sensor shorted.
E4	Temperature sensor circuit failure.
E8	Latch time-out overflow.
E16	Free.
E32	Free.
E64	Mode selector disconnected. Cannot be reset.
OTHER	Sum of error codes simultaneously detected.

Cooking mode table with preset, minimum, maximum temperatures (°C) and nominal power (Watt)

N°	MODE	PRESE (°C)	TMIN (°C)	TMAX (°C)	HEATING ELEMENTS (W)	NAME
0	0					ZERO
1		##	##	##		LIGHT
2		80	50	100	400	KEEP WARM
3		210	50	250	2200	BAKE
4		210	50	250	2200	ECO-BAKE
5		210	50	250	1200	LOWER BAKE
6		##	##	##		DEFROST
7		190	50	250	1200	LOWER CONVECTION BAKE
8		190	50	250	2200	CONVECTION ROAST
9		190	50	250	2300	CONVECTION BAKE
10		230	50	250	2000	CONVECTION GRILL
11		230	50	250	2000	GRILL
12		230	50	250	2000	GRILL + TURNSPIT
13		230	50	250	3000	SUPER GRILL
14		475			2400	PYRO (THERMAL)
15		475			2400	PYRO

DOOR LOCKING SYSTEM

Automatic door locking during pyrolytic cycle

For safety reasons, the door is locked automatically as soon as self-clean mode is selected (both standard, both eco clean). The door is also unlocked automatically when the clean time has expired but only after the temperature has fallen below the safety threshold.

NOTE

It is not possible to exclude the door locking device during self-cleaning i.e. manually unlock the door since the self-cleaning mode has the highest priority and overrides all other selections.

The lock symbol (▶) on the display is:

ON	When the door is fully locked
OFF	When the door is fully unlocked
FLASHING	When the latch mechanism is moving. (After self clean the symbol will flash until the temperature will be safe and the door unlocked).

Oven lights

They turn on during all cooking activities but they are always disabled in self-clean.

CLEANING AND MAINTENANCE

Prior to taking any action for cleaning, make sure the apparatus is cut-out from the mains.

It is recommended that the oven interior be frequently cleaned. In particular, it should be cleaned every time the grill is used to prevent excessive fouling of the oven interior that may generate fumes or odours during subsequent cooking. Abrasive detergents and steam cleaning equipment should not be used for cleaning.

WARNING

Do not use harsh abrasive cleaners or sharp metal scrapers to clean the oven door glass since they can scratch the surface, which may result in shattering of the glass.

Ovens provided with the hot air system are less subject to dirt inside.

Self-cleaning cycle (pyrolytic cycles)

Although it is not necessary to perform the cleaning operation each time the oven has been used, do not let the oven get too dirty.

Before performing self-cleaning, take out all accessories (grills, dishes, pans) to avoid damaging them, remove large cooking residues and then close the door, ensuring that it is closed properly.

NOTE

Usually self-cleaning requires 2.30 to 3 hours according to the amount of residue to be removed.

WARNING

Ensure that the door is in the closed position before the self-cleaning cycle starts, otherwise automatic door locking will not be completed. See paragraphs that follows.

When the cycle is finished and the oven has **COOLED COMPLETELY**, remove the burned-off residues of the self-cleaning cycle with a damp cloth.

Removing the “FULL GLASS” panoramic door

WARNING

Make sure that:

- The oven is cool and power to the oven has been turned off before removing the door. Failure to do so could result in electrical shock or burns.
- The oven door is heavy and fragile. Use both hands to remove the oven door. The door front is glass. Handle carefully to avoid breakage.
- Grasp only the sides of the oven door. Do not grasp the handle as it may swing in your hand and cause damage or injury.
- Failure to grasp the oven door firmly and properly could result in personal injury or product damage.

Removing the oven door

The oven door can be removed quickly and easily. To do so, proceed as follows:

- Open the door fully.
 - Lift the two levers shown below.
 - Close the door as far as the first stop (caused by the raised levers).
 - Lift the door upwards and outwards to remove it from its mountings.
- To replace fit the door, fit the hinges in their mountings and lower the two levers

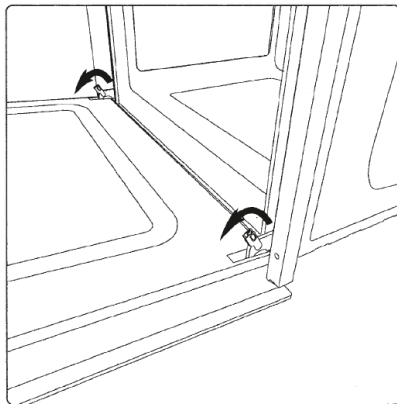
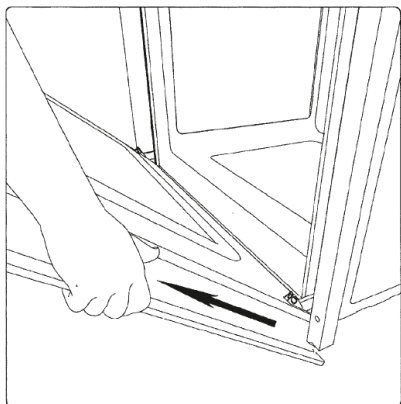

How to remove the inner glass of the “FULL GLASS” panoramic door

1. Wear protective gloves.
2. Place the door on a flat horizontal surface face down on a soft cloth to avoid scratching the visible part.
3. Simultaneously press the keys of the two side covers, removing the upper strip.



4. Slide out the internal glass as shown below. Remove the second and third panes of glass (middle panes) for cleaning sliding out the rubber strip.

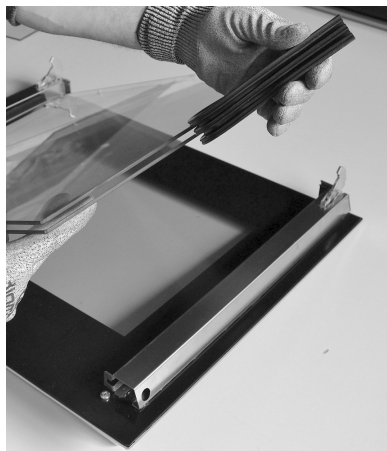
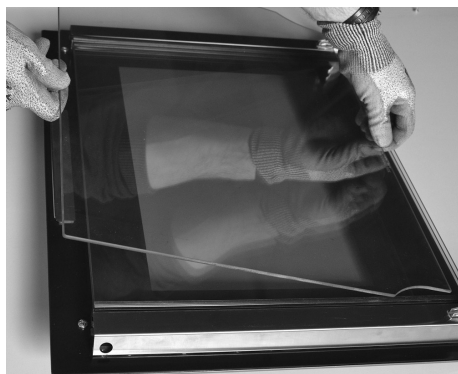

5. Replace the middle panes after cleaning in reverse order, checking that they are oriented so the words INTERNAL SIDE are properly legible.

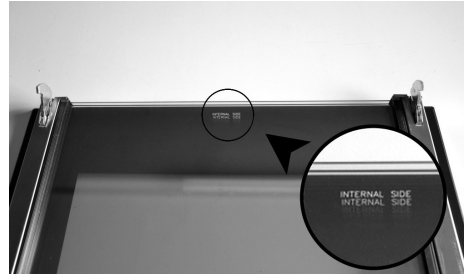
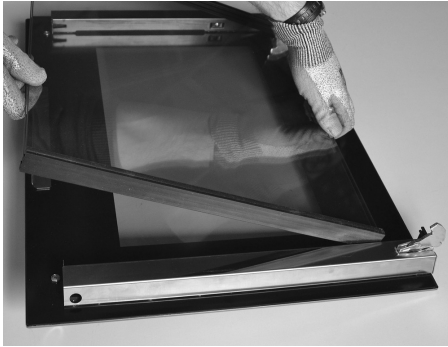

NOTE: a slight gap between the middle panes and the side supports is normal because it allows for the heat expansion of the glass.

6. Place the pack of three glass panes between the two uprights and replace the top strip.

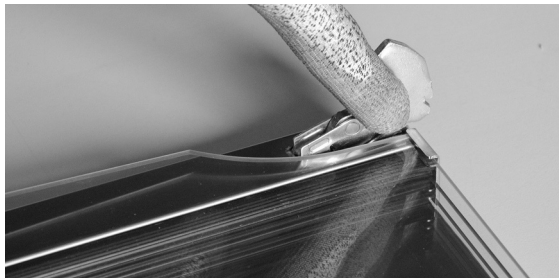

Replacement of the oven light

WARNING

Make sure that:

- The oven and lights are cool and power to the oven has been turned off before replacing the light bulb(s). Failure to do so could result in electrical shock or burns.
- The lenses must be in place when using the oven.
- The lenses serve to protect the light bulb from breaking.
- The lenses are made of glass. Handle carefully to avoid breakage. Broken glass could cause an injury.

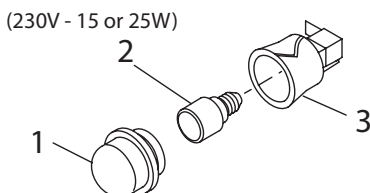
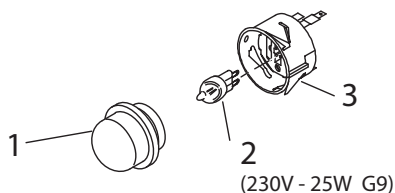

- 1 Turn off power at the main power supply (fuse or breaker box).
- 2 Remove the lens (1) by unscrewing it.
- 3 Remove the light bulb (2) from its socket (3).
- 4 Replace the bulb (2) with a new one. Avoid touching the bulb with fingers, as oils from hands can damage the bulb when it becomes hot.
- 5 Use one with the same Volt and Watt (see figure).
- 6 Screw the lens (1) back on.
- 7 Turn power back on at the main power supply (fuse or breaker box).

GUIDANCE TEMPERATURE AN TIME SCHEDULE FOR COOKING

FOOD	Mode	Rack position (from the bottom)	Traditional cooking system		Hot-air cooking system	
			Temperature °C	Cooking time in minutes	Temperature °C	Cooking time in minutes
Poork, calf (roast) etc.		2nd	200 ÷ 225	100 ÷ 150	175 ÷ 180	90 ÷ 120
Filett, Roastbeef		2nd	240 ÷ 250	40 ÷ 50	210 ÷ 225	20 ÷ 30
Poultry (goose, duck, turkey, chicken) whole (4)		1st	190 ÷ 240	150 ÷ 180	180 ÷ 225	60 ÷ 75
Chicken		2nd	225 ÷ 250	30 ÷ 45	210 ÷ 225	45 ÷ 60
Hamburger, Chops of Lamb, Chicken thighs		3th	200 ÷ 220	10 ÷ 20 for each side	180 ÷ 190	10 ÷ 15 for each side
Game (4)		1st	210 ÷ 230	80 ÷ 100	250	45 ÷ 60
Fish		1st	180 ÷ 190	35 ÷ 45	175 ÷ 180	35 ÷ 45
Cakes		1st	170 ÷ 200	40 ÷ 80	150 ÷ 170	35 ÷ 70
Biscuits		2nd	225	10 ÷ 20	170 ÷ 180	10 ÷ 15
Pizza		2nd	210 ÷ 240	15 ÷ 20	200 ÷ 210	10 ÷ 12
Pizza Multilevel		2nd & 3th or 2nd & 4th			200 ÷ 210	15 ÷ 20

Warning for hot-air cooking - Position of pans:

- For cooking on 1 plane make use on 2nd holder from the bottom
- For cooking on 2 planes make use of 2nd - 4th holders from the bottom
- For cooking on 3 planes make use of 2nd - 3th and 4th holders from the bottom
- (4) The time depends of poultry dimension, (40 ÷ 45 mins for kg).

IMPORTANT: The cooking times are considered with oven preheated.

Eurolinx Pty Limited A.B.N. 50 001 473 347
trading as ILVE ("ILVE")

Office:

48-50 Moore Street, Leichhardt N.S.W 2040
Post:

Locked Bag 3000, Annandale, N.S.W 2038
P: 1300 856 411

WARRANTY REGISTRATION

Your ongoing satisfaction with your ILVE product is important to us. We ask that you complete the enclosed Warranty Registration Card and return it to us so that we have a record of the ILVE products you purchased. Alternatively you can register on line (see registration card for details)

PRIVACY

ILVE respects your privacy and is committed to handling your personal information in accordance with the National Privacy Principles and the Privacy Act 1988 (Cth). A copy of the ILVE Privacy Policy is available at www.ilve.com.au. ILVE will not disclose any personal information set out in the Warranty Registration Card ("Personal Information") without your consent unless required by:

1. law;
2. any ILVE related company;
3. any service provider which provide services to ILVE or assist ILVE in providing services (including repair and warranty services) to customers. Our purpose in collecting the Personal Information is

to keep a record of the ILVE product purchased by you, in order to provide a better warranty service to you in the unlikely event that there is a problem with your ILVE product. ILVE may contact you at any one or more of the address, email address or telephone numbers set out in the Warranty Registration Card. Please contact ILVE on 1300 694 583 should you not wish to be contacted by ILVE.

WARRANTY

1. Warranty

ILVE warrants that each ILVE product will remain, for a period of twenty four (24) months computed from the date of purchase of the ILVE product, free from defects arising in the manufacture of the ILVE product ("Warranty"). Except for consumer guarantees set out in the Competition and Consumer Act 2010 (Cth) ("Act"), ILVE does not make any further warranties or representations in relation to ILVE products.

2. What is not Covered by the Warranty.

The Warranty does not apply if an ILVE product is defective by a factor other than a defect arising in the manufacture of the ILVE product, including but not limited to:

- (a) damage through misuse (including failure to maintain, service or use with proper care), neglect, accident or ordinary wear and tear (including deterioration of parts and accessories and glass breakage);
- (b) use for purpose for which the ILVE product was not sold or designed;
- (c) use or installation which is not in accordance with any specified instructions for use or installation;
- (d) use or operation after a defect has occurred or been discovered;
- (e) damage through freight, transportation or handling in transit (other than when ILVE is responsible);
- (f) damage through exposure to chemicals, dusts, residues, excessive voltage, heat, atmospheric conditions or other forces or environmental factors outside the control or ILVE;
- (g) repair, modification or tampering by the purchaser or any person other than ILVE, an employee of ILVE or an authorised ILVE service contractor;
- (h) use of parts, components or accessories which have not been supplied or specifically approved by ILVE.
- (i) damage to surface coatings caused by cleaning or maintenance using products not recommended in the ILVE product handbook provided to the purchaser upon purchase of the ILVE product;
- (j) damage to the base of an electric oven due to items having been placed on the base of the oven cavity or covering the base, such as aluminium foil (this impedes the transfer of heat from the element to the oven cavity and can result in irreparable damage); or
- (k) damages, dents or other cosmetic imperfections not affecting the performance of the ILVE in respect of an ILVE product purchased as a "factory second" or from display.

The Warranty does not extend to light globes used in ILVE products.

Customers must retain proof of purchase in order to be eligible to make a warranty claim in respect of an ILVE product.

6. Claiming under the Warranty

Customers will bear the cost of claiming under this Warranty unless ILVE determines the expenses are reasonable, in which case the customer must claim those expenses by providing written evidence of each expense to ILVE at the address on the Warranty Registration Card.

3. Domestic Use

Each ILVE product is made for domestic use. This Warranty may not extend to ILVE products used for commercial purposes; under those circumstances the warranty period is limited to 3 months.

4. Time for Claim under the Warranty

You must make any claim under this Warranty within twenty eight (28) days after the occurrence of an event which gives rise to a claim pursuant to the Warranty, by booking a service call on the telephone number below.

5. Proof of Purchase

Customers must retain proof of purchase in order to be eligible to make a warranty claim in respect of an ILVE product.

6. Claiming under the Warranty

Customers will bear the cost of claiming under this Warranty unless ILVE determines the expenses are reasonable, in which case the customer must claim those expenses by providing written evidence of each expense to ILVE at the address on the Warranty Registration Card.

7. Statutory Rights

(a) These terms and conditions do not affect your statutory rights.

(b) The limitations on the Warranty set out in this document do not exclude or limit the application of the

consumer guarantees set out in the Act or any other

equivalent or corresponding legislation in the relevant

jurisdiction where to do so would:

(i) contravene the law of the relevant jurisdiction; or

(ii) cause any part of the Warranty to be void.

(c) ILVE excludes indirect or consequential loss of any kind (including, without limitation, loss of use of the

ILVE product) and (other than expressly provided for in these terms and conditions) subject to all terms,

conditions and warranties implied by custom, the general law, the Act or other statute.

IMPORTANT!

All warranty service calls must be booked via the customer care department. The team can be contacted on 1 300 85 64 11 option 1 or customercare@eurolinx.com.au

Service is delivered through a network of Service Agents. If the Appliance is located outside our normal Service Area of our agents you, the Customer will need to bear the cost of travel outside that area.

If you are unable to provide proof of purchase, the fault is not covered under warranty or the product is found to be working to specification you may be required to bear the full cost of the service visit

01072016

Warranty Card tear off

WARRANTY REGISTRATION CARD
01012013

Please complete and send to ILVE at: REPLY PAID 83617
LEICHHARDT NSW 2040

Last Name:		First Name:	
Address:			
State:	Postcode:	Email:	
Home Phone:		Mobile:	
Purchase Date: / /		(Please attach proof of purchase to validate warranty)	

MODEL NUMBER	SERIAL NUMBER (if you cannot locate the serial number please call ILVE on 1300 85 64 11)
1	
2	
3	
4	

01072016

Australia National Telephone Number 1300 MYILVE (694 583) New Zealand Telephone Number 0508 458 369
ILVE showrooms are open daily from 9am-5pm and Saturdays 10am-4pm

ilve.com.au

NSW & ACT (Head Office)

48-50 Moore Street
Leichhardt
F 02 8569 4699

VIC & SA

1211 Toorak Road
Camberwell
F 03 9809 2155

QLD

1/42 Cavendish Road
Coorparoo
F 07 3397 0850

WA & NT

Unit 10/55 Howe Street
Osborne Park
F 08 9201 9188

TAS (Crisp Ikin)

3 Pear Avenue
Derwent Park, 7009
P 03 6272 7386

New Zealand

PO Box 11.160
Sockburn Christchurch
F 03 344 5906