8kg Vented Dryer

MVD28B

MVD28W

Welcome

Residentia Group

—
Head Office
165 Barkly Avenue
Burnley, Victoria
Australia 3121

—
ACN
600 546 656

—
Online
residentia.group
www.mykin.house

—
Postage
PO Box 5177
Burnley, Victoria
Australia 3121

—
Telephone
1300 11 4357

Congratulations on purchasing your new Vented Dryer. The Mykin brand is proudly distributed within Australia by Residentia Group Pty Ltd.

Please refer to the warranty card at the rear of this manual for information regarding your product's parts and labour warranty, or visit us online at: www.residentia.group

At Residentia Group, we are customer obsessed and our Support Team are there to ensure you get the most out of your appliance. Should you want to learn more about your new dishwasher, it's features or importantly taking care of the appliance, our Support Team are here to help.

You can use our online Support Centre at anytime by visiting: <http://support.residentiagroup.com.au>

Or you can contact us via phone by dialing: 1300 11 HELP (4357).

It is important that you read through the following use and care manual thoroughly to familiarise yourself with the installation and operation requirements of your appliance to ensure optimum performance.

Again, thank you for choosing a Mykin appliance and we look forward to being of service to you.

Kind Regards,
The Residentia Team

Contents

PAGE 02
WELCOME

PAGE 04
SAFETY INFORMATION

PAGE 09
YOUR VENTED DRYER

PAGE 10
INSTALLATION
INSTRUCTIONS

PAGE 13
PRECAUTIONS
BEFORE USE

PAGE 15
OPERATING YOUR
VENTED DRYER

PAGE 20
CLEANING AND
MAINTENANCE

PAGE 21
TROUBLESHOOTING

PAGE 23
TECHNICAL
SPECIFICATIONS

PAGE 24
YOUR RECEIPT

PAGE 25
PURCHASE DETAILS

PAGE 26
WARRANTY
INFORMATION

Safety Information

GENERAL SAFETY INSTRUCTIONS

SAFETY WARNING AND PRECAUTIONS

Your safety and the correct operation of the machine are paramount. Please read these warnings carefully.

- **WARNING!** or **CAUTION!** Violation of a marking may result in serious personal injury and death.
- **IMPORTANT!** Violation of a marking may cause minor personal injury or damage to objects.

DRYER SAFETY

WARNING! Failure to follow these safety instructions could damage the clothes dryer or your clothes. You may then not be covered by warranty for this damage.

Only plug this appliance directly into an AC power supply which is properly earthed and had the correct voltage.

Refer to the appliance rating plate (located on the rear of your clothes dryer) for the voltage information.

CAUTION! If this appliance is supplied from an extension cord, power-board or other power adapter, the extension cord/power-board must be positioned so that it is not subject to moisture or risk of moisture. For safety reasons, we strongly advise against the use of double adaptors, power-boards, extension leads or other similar devices.

This appliance is not intended for use by persons (including children) with reduced physical, sensory or mental capabilities, or a lack of experience and knowledge, unless they have been given supervision or instruction concerning use of the appliance by a person responsible for their safety. Children should be supervised to ensure that they do not play with the appliance.

IMPORTANT!

- The lint trap filter must be cleaned after each use.
- If the electrical cord of this appliance is damaged, it must be replaced by the Manufacturer, Authorised Service Agent or similarly qualified person in order to avoid a hazard. Damage to the appliance, including the power cord, is not covered under the manufacturer's warranty and a fee for service may be payable.
- These dryers are for drying clothes, towels and linen at home. They are not designed or intended for use in Commercial environments. Do not use them for any other purpose.
- The dryer is not to be used with any clothing articles which have had industrial chemicals used for cleaning.
- This appliance is only intended for use indoors only within a domestic environment.
- Adequate ventilation must be provided.
- Never dry unwashed items with your clothes dryer.
- Never use your clothes dryer to dry items such as latex, foam rubber, waterproof textiles, rubber backed articles, or pillows fitted with foam.
- Ensure all objects are removed from pockets.
- Lint must not be allowed to accumulate around the tumble dryer.
- Always check your clothing items care labels to ensure they are suitable for use within your dryer.

WARNING! The final cycle of your clothes dryer programs is a cool down cycle to reduce the temperature of your clothes. This is incredibly important to ensure that your clothing items won't be damaged. Never stop a tumble dryer before the end of the drying cycle unless all items are quickly removed and spread out so that the heat is dissipated.

Safety Information (Continued)

WARNING!

Lint filter must be cleaned after each use.

CAUTION:

Do not operate the dryer without the lint filter installed.

Safety Information (Continued)

FIRE HAZARDS

Some fabrics are not suitable for tumble drying. The following **MUST NOT** be placed in your dryer due to the risk of a fire or an explosion:

- Item(s) that have been spotted or soaked with vegetable oil, cooking oil, suntan oil, linseed oil, salad oil, lubrication oil or grease. Oil affected items can ignite spontaneously, especially when exposed to heat sources such as in a tumble dryer. The items become warm, causing an oxidation reaction in the oil. Oxidation creates heat. If heat cannot escape, the items can become hot enough to ignite. Pilling, stacking or storing oil-affected items can prevent heat from escaping and create a fire hazard. If it is unavoidable that fabrics that contain vegetable or cooking oil or have been contaminated by hair care products be placed in a tumble dryer, they should first be washed in hot water with extra detergent — this will reduce, but not eliminate the hazard. The final part of the tumble dryer cycle occurs without heat (Cooling cycle) to ensure that the items are left at the temperature that ensures that the items will not be damaged.
- Item(s) that have previously been cleaned in, washed in, or spotted with petrol/gasoline, industrial chemicals used only for cleaning, dry-cleaning solvents or other flammable or explosive substances are highly flammable. Highly flammable or explosive substances commonly found around the house include acetone, (nail polish remover) denatured alcohol, petrol/gasoline, kerosene, some spot removers, turpentine, waxes and wax removers should not be put in the dryer. Items containing foam rubber (also known as latex foam) or similarly textured rubber-like materials. Foam rubber materials can produce fire by spontaneous combustion when heated.
- Rubber-backed articles, clothes fitted with foam rubber pads, pillows, rubber boots and rubber-coated sports shoes.

WARNING! For your safety, and to reduce the risk of fire or an explosion, **DO NOT** store or use petrol or other inflammable vapours and liquids near your dryer.

CLEANING THE LINT FILTER AFTER EVERY USE

THE LINT FILTER MUST BE INSTALLED FOR EVERY USE

WARNING! LINT BUILD-UP IS A FIRE HAZARD.

A clean lint filter greatly improves your dryer's efficiency and reduces drying times, saves energy and avoids overheating. Overheating may also damage your clothes.

Tip! If your lint filter isn't emptied between drying loads, we estimate the drying time can double after 4–5 cycles and triple after 8 cycles. Aside from creating a risk of fire, this results in a significant increase in energy consumption to dry your clothes.

The lint filter is located on the inside of the door, Figure 1 shown below.

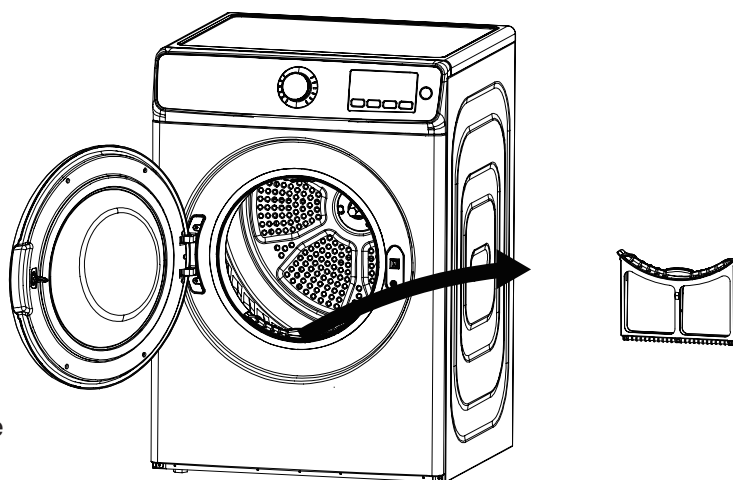

Figure 1 — Lint filter location within your vented dryer.

Safety Information (Continued)

WARNING! You must empty your lint filter after every load and have it installed on every load.

To remove the lint filter, open the dryer door and simply lift the plastic filter out from its housing. You can click the lint filter open to allow easy access to remove the lint. Ensure that the plastic filter is clicked closed again before replacing into your clothes dryer.

Tip! The lint filter can only be inserted into its housing in one way and must be used on every load.

IMPORTANT!

- Never operate your dryer without the lint filter in its correct position.
- Do not allow lint to build up around the dryer (on the door itself, inside the drum, around the lint filter itself, etc).
- A torn or damaged lint filter must be replaced immediately — cease use until this is replaced.
- Do not overload your dryer. Overloading can increase lint build-up because the airflow is reduced.

Tip! To avoid potential fire hazards, we recommend that you pay for a qualified appliance technician to inspect and clean your dryer periodical and if you have been using the dryer and want to wall mount the unit we recommend to have the dryer professional clean before doing so.

OPERATING YOUR DRYER

Your dryer is rated to 8kg of dry clothing. Loads must not exceed this rated capacity.

IMPORTANT! Always check your clothing's care label information to ensure they are suitable for use within dryers.

Excessive drying is one of the most damaging things we do to our laundry. International drying symbols (shown below) help you select a dryer cycle and a temperature.



Figure 2 — International drying symbols used on your clothing care labels.

- If the care label has a circle inside a square, your item can be tumble dried.
- The more dots on the iron symbol suggests the temperature of heat that can be applied:
 - 1 dot = low temperature
 - 2 dots = medium temperature
 - 3 dots = high temperature
- If there is a cross over the tumble dry symbol, you should not tumble dry the item. It's recommended for air-drying only.

Some guidelines for various fabric types:

- Permanent press and synthetics — Take out as soon as the dryer stops to reduce wrinkles.
- Woollen articles - not recommended. Pull them to their original shape, then dry them flat. Vented dryers can shrink woollen articles.
- Woven and loop knit materials — May shrink, by varying amount, depending on their quality. Do not use the "Heavy" Dryness setting for these fabrics, Always stretch them out immediately after drying.
- Fibre or leather materials — Always check the manufacturer's instructions.
- Baby clothes and night gowns — Acrylic clothing or sleepwear use only on the lighter dryness settings.
- Rubber and plastics — Do not dry any items made from or containing rubber or plastics, such as aprons, bibs, babies' water proof napkins, curtains, tablecloths, shower caps, clothes fitted with foam rubber pads, pillows, galoshes, or rubber coated tennis shoes.
- Fibreglass — Not recommended, glass particles left in the dryer could be picked up by your clothes the next time you use the dryer and irritate your skin.

Safety Information (Continued)

CAUTION! Fabric softeners or similar products should not be used in a tumble dryer to eliminate the effects of static electricity unless this practice is specifically recommended by the manufacturer of the fabric softener or product.

Note: We strongly advise against the use of fabric conditioners of the sheet type that are added to the clothes in the drum. These products may lead to rapid blockage of the lint filter and inefficient operation of your dryer.

UNPACKING

During transportation, protective packaging was used to protect the appliance against any damage. After unpacking, please dispose of all elements of packaging in a way that will not cause damage to the environment. All materials used for packaging the appliance are environmentally friendly; they are 100% recyclable and are marked with the appropriate symbol. Check with your local council on which packaging elements can be recycled kerbside and which may need to be disposed of at your local recycling drop off centre.

Tip! Soft plastics can be recycled at most major grocery retailers. Polystyrene (EPS) foam may not be accepted by your local council for recycling - check <http://epsa.org.au/> for details of your local EPS recycler.

CAUTION! During unpacking, the packaging materials (polythene bags, polystyrene pieces, etc.) should be kept out of reach of children.

DISPOSAL

Old appliances should not simply be disposed of with normal household waste but should be delivered to a collection and recycling centre for electric and electronic equipment. A symbol shown on the product, the instruction manual or the packaging shows that it is suitable for recycling.

- Materials used to manufacture the appliance are recyclable and are labelled with information concerning this. By recycling materials or other parts from used devices you are making a significant contribution to the protection of our environment.
- Information on appropriate disposal centres for used devices can be provided by your local council or authority.

Your Vented Dryer

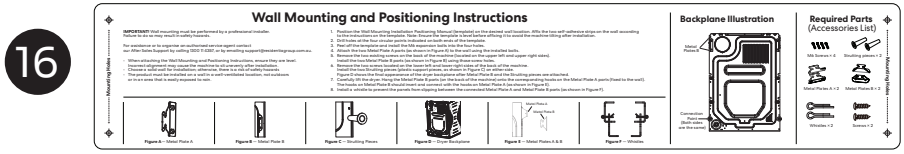
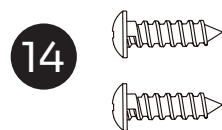
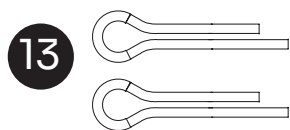
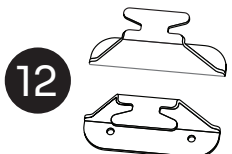
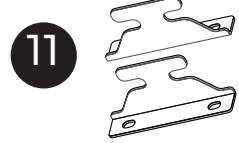
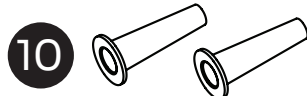
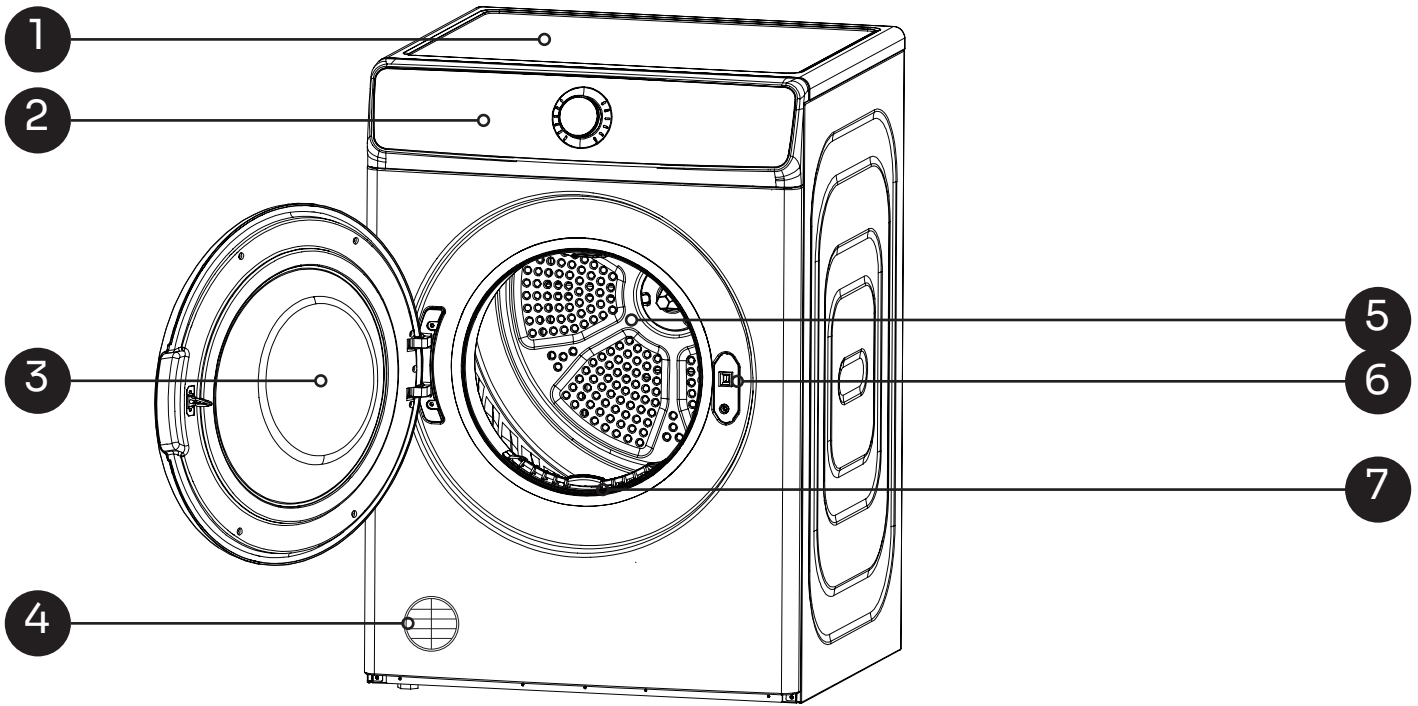

1. Top Cover	2. Control Panel	3. Door	4. Air Outlet Protective Cover
5. Inner Tub	6. Door Lock	7. Lint Filter	8. Cabinet
9. M6 Screws × 4	10. Strutting Pieces × 2	11. Metal Plates A × 2	12. Metal Plates B × 2
13. Whistles × 2	14. Screws × 2	15. Inverted Panel Sticker	16. Wall Mounting Guide

Figure 3 — A diagram showing the main components and accessories of your vented dryer.

Installation Instructions

AIR OUTLET PROTECTIVE COVER

- The Air Outlet Protective Cover must be installed before the appliance is used.
- The cover is located at the lower left corner on the front of the dryer.
- It can be fitted by pressing it into place and manually rotating it to adjust the air outlet direction as required.
- The dryer must only be powered on and used once the air outlet protective cover has been correctly installed.

DRYER INSTALLATION LOCATION AND SAFETY REQUIREMENTS

The correct location is critical for the safe and efficient operation of your vented dryer.

- The dryer must be installed in a well-ventilated area.
- Do not install the dryer outdoors or in any location exposed to rain or dampness.
- **WARNING!** Never install the dryer in a place where petrol (gasoline) or other flammable materials or vapours are stored.

INSTALLATION LOCATION AND MINIMUM CLEARANCE REQUIRED

The following minimum clearances must be maintained:

- **Rear Wall Clearance:** Maintain a minimum of 10 cm (100 mm) of clear space between the back of the dryer and the wall. This space is required for ensuring sufficient air circulation.

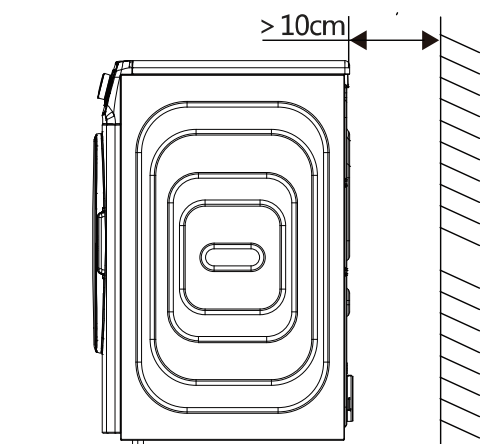

- **Closed Room Clearance:** If installing the dryer in a small, closed room (like a bathroom or small laundry), maintain a minimum clear distance of 1.5 metres from the front of the dryer to any opposing wall or obstacle. This ensures adequate air intake and prevents the appliance from overheating.

ENSURING LEVEL PLACEMENT

The dryer must be stable and level before use.

- Place the dryer on a firm, level surface.
- If the dryer's feet are not all sitting flat, you can use a solid packer or levelling shim under the foot to correct it.
- **IMPORTANT!** If the dryer is installed on a floor that is tilted (or 'not level') by more than 2°, it may cause the machine to run unevenly or stop midway through a cycle.

WALL MOUNTING (IF APPLICABLE)

IMPORTANT! We recommend that wall mounting should only be performed by a qualified professional.

- The wall used for mounting must be solid and structurally sound (e.g., brick, or timber-framed and properly reinforced). Installing on an unsuitable wall creates a security risk.
- The mounted dryer must still be placed in a location with good ventilation and sheltered from rain.
- To ensure stability and prevent the machine from tilting after it's been attached, the installer must strictly follow the separate positioning instructions.
- For the complete, detailed wall-mounting procedure, please refer to the separate Wall Mounting and Positioning Instructions provided with your machine.



Installation Instructions (Continued)

WALL MOUNTING AND POSITIONING INSTRUCTIONS

Tip! The following are included in the Wall Mounting and Positioning Instructions provided with your Vented Dryer.

IMPORTANT! Wall mounting must be performed by a professional installer. Failure to do so may result in safety hazards. For assistance or to organise an authorised service agent contact our After Sales Support by calling 1300 11 4357, or by emailing support@residentiagroup.com.au.

- When attaching the Wall Mounting and Positioning Instructions, ensure they are level. Incorrect alignment may cause the machine to sit unevenly after installation.
- Choose a solid wall for installation; otherwise, there is a risk of safety hazards
- The product must be installed on a wall in a well-ventilated location, not outdoors or in an area that is easily exposed to rain.

REQUIRED PARTS (ACCESSORIES LIST)

The following parts are required for wall mounting:

- Metal Plates A (Wall Bracket) × 2
- Metal Plates B (Dryer Bracket) × 2
- Strutting pieces (Plastic Support) × 2
- M6 Screw (Expansion Bolt) × 4
- Whistle (Split Pin/Locking Screw) × 2
- Screw × 2

STEP-BY-STEP INSTALLATION PROCEDURE

Part 1: Preparing the Wall (Wall Brackets)

1. **Positioning the Template:** Position the Wall Mounting Installation Positioning Manual (template) on the desired wall location. Affix the two self-adhesive strips on the wall according to the instructions on the template.
Note: Ensure the template is level before affixing it to avoid the machine tilting after installation.
2. **Drill Holes:** Drill holes at the four circular points indicated on both ends of the template.
3. **Install Bolts:** Peel off the template and install the M6 expansion bolts into the four holes.
4. **Attach Metal Plate A:** Attach the two Metal Plate A parts (as shown in Figure A) to the wall using the installed bolts.

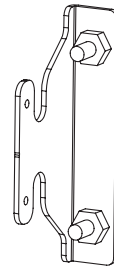

Figure A — Metal Plate A

Part 2: Preparing the Dryer (Dryer Brackets)

1. **Install Metal Plate B (Top):** Remove the two existing screws on the back of the machine (located on the upper left and upper right sides). Install the two Metal Plate B parts (as shown in Figure B) using those screw holes.

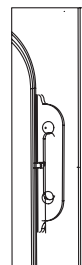

Figure B — Metal Plate B

Installation Instructions (Continued)

2. **Install Supports (Bottom):** Remove the two screws located on the lower left and lower right sides of the back of the machine. Install the two Strutting pieces (plastic support pieces, as shown in Figure C) on either side. Figure D shows the final appearance of the dryer backplane after Metal Plate B and the Strutting pieces are attached.

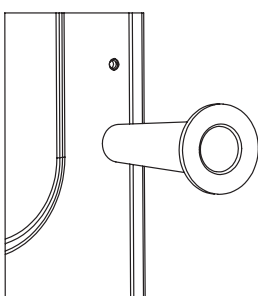

Figure C — Strutting Pieces

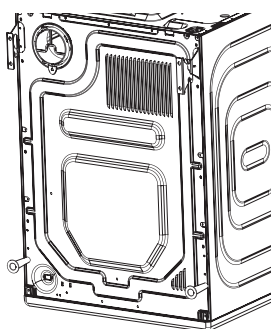

Figure D — Backplane

Part 3: Final Mounting and Securing

1. **Hanging the Dryer:** Carefully lift the dryer. Hang the Metal Plate B parts (on the back of the machine) onto the corresponding hooks on the Metal Plate A parts (fixed to the wall). The hooks on Metal Plate B should insert and connect with the hooks on Metal Plate A (as shown in Figure E).

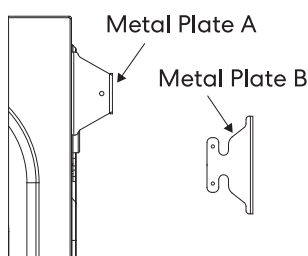

Figure E — Metal Plates A & B

2. **Securing the Connection:** Install a whistle to prevent the panels from slipping between the connected Metal Plate A and Metal Plate B parts (as shown in Figure F).

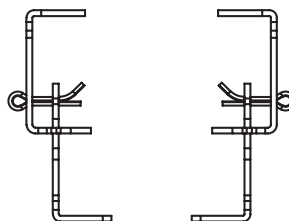

Figure F — Whistles

APPLYING THE INVERTED CONTROL PANEL STICKER TO THE INVERTED DRYER

Follow these instructions to safely remove the control dial and apply the reverse control panel sticker when installing the dryer in an inverted position.

Tools Required

- Flathead screwdriver
- Reverse control panel sticker

Installation Steps

1. **Remove the Control Dial:** Carefully insert a flathead screwdriver behind the main control dial. Gently pry outwards around the edges to pop the dial off the front panel of the dryer.
2. **Apply the Inverted Sticker:** Thoroughly clean the surface area and ensure it is completely dry. Peel the backing off the reverse control panel sticker, align it correctly over the existing dial cut-out, and press it firmly into place, ensuring there are no air bubbles.
3. **Reattach the Control Dial:** Place the dial back over the exposed central shaft. Look inside the back of the dial and match the flat side of the inner plastic moulding with the corresponding flat side on the dryer's shaft. Press firmly until it is securely into position.

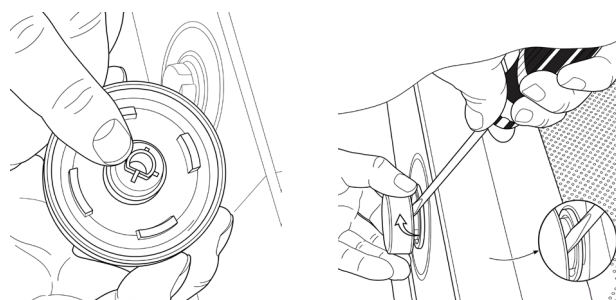

Precautions Before Use

POWER SUPPLY AND GROUNDING

- The machine operates using alternating current (AC). It can be used normally as long as the voltage is within a 10% tolerance of the specified value.
- For convenient and safe use, it is best to install a dedicated power socket specifically for the dryer.
- The dryer's plug connection includes a ground wire, as illustrated on the right.
- * In the course of using the dryer, always pay attention to the safety contents and use common sense to ensure safe operation. The manufacturer is not responsible for any loss caused by improper use or disregard of safety precautions.

ELECTRICAL CONNECTION

- This product belongs to Class I electrical appliances. Pay careful attention to electrical safety when using!
- Reliable grounding is mandatory for the power supply. The ground wires of electric wires must be buried in the earth and must not be connected to water pipes, gas pipelines, or other public facilities.
- The ground wires and zero wires of the electric power supply must not be separated, and the two live wires cannot be connected together.
- Special sockets (power outlets) must be used separately. Sockets must be qualified products that comply with all compulsory national certifications and must be capable of carrying more than 10A of current.
- For your safety and the safety of your family, do not use the machine if the electricity requirements are not met. This is strictly prohibited.

ADDITIONAL ELECTRICAL ATTENTIONS:

1. To prevent accidents during installation and use, and to ensure electrical safety, it is necessary for personnel with electrical knowledge to install sockets and correctly connect the baseline.
2. It is forbidden to connect the ground wire with the fire wire (live) or zero wire (neutral). Otherwise, the shell (casing) of the dryer will become charged (live), which can easily lead to an electric shock.
3. If the power supply is found to be damaged, it must be replaced by qualified professionals.
4. When the dryer is no longer working, it is best to remove the power plug from the socket to ensure absolute safety.

WORKING ENVIRONMENT AND INSTALLATION

- It is forbidden to store flammable or explosive materials around the dryer. Do not use flammable sprays near the dryer when it is running.
- If gas or flammable gas leaks occur, do not plug or unplug the power supply and do not turn the machine on or off. Ventilate the area immediately.
- The dryer should not be installed in an open air or humid environment. If the machine is accidentally drenched or there is a water leakage incident, it must be ventilated and fully dried (aired) before ensuring the electrical components are safe for use.
- Do not place items on top of the dryer, especially hot or heavy items (e.g., hot pots or water vessels).
- For the rear type air outlet, it is forbidden to connect the extension tube of the dryer to a flue to prevent smoke and dust from being refilled (drawn back in).
- Be careful when the dryer is working, as the back cover board will be hot when steam is exhausted. For safety reasons, do not allow unattended children or physically disabled persons to use this machine.

Precautions Before Use (Continued)

MATTERS NEED ATTENTION (PROHIBITIONS AND USAGE)

- Do not unplug the power cord or switch the power when the dryer is running. This can damage the components or lead to electric shock if done with wet hands.
- Do not pull the power cord directly. When not in use or cleaning, ensure to unplug the power cord first by holding the plug head.
- **WARNING!** Risk of fire and explosion: Do not dry clothes with flammable detergents, dry cleaning solvents, spot removers, acetone, cooking oil, gasoline, kerosene, alcohol, turpentine, wax, and wax remover, etc.
- Do not put dripping wet clothes in the dryer. Clothes must be adequately pre-dehydrated (spun dry) before placement to prevent rust and damage to the dryer and other hazards caused by water dropping onto electrical parts.
- **WARNING!** Can cause damage or fire: Do not dry items with rubber or objects similar to elastic material (e.g., raincoats, bicycle covers, etc.).
- **WARNING!** Risk of explosion or fire: Do not store cigarettes, lighters, dry ice, gasoline, and other flammable or explosive materials in the dryer. |
- Do not use the machine if the items are made of fabrics that are not allowed to dry in a dryer or if they have the above warning marks (e.g., Do not dry in rollers, Drip-dry, Flat dry, Dry in the shade). Follow clothing care labels strictly.
- **CAUTION!** Be cautious of steam/hot air escaping upon opening: It is advised not to open the door before the end of the dryer program to avoid burns.
- Do not disassemble, repair, or modify the machine yourself. This can be dangerous and will void your warranty. Contact qualified professionals only. For assistance or to organise an authorised service agent contact our After Sales Support by calling 1300 11 4357, or by emailing support@residentialgroup.com.au.
- **WARNING!** Risk of electric shock: Do not touch or use the dryer when your hands or feet are wet, or when you are barefoot.

MAINTENANCE AND SETUP CAUTION

1. If a grounding leakage (ground protection) circuit breaker is required, the symbol must be included on the display. This symbol ensures that the power plug matches the socket requirements.
2. For safety, only use the original parts and accessories supplied by the manufacturer.
3. Do not place the machine on a carpet or foam padding. This will cause difficulty in heat dissipation and may damage the machine or other objects.
4. Do not use the dryer on a table above the ground to prevent the dryer from falling.
5. Clean the filter before and after each use. The dryer and the surrounding cotton wool (lint) should be regularly cleaned as well.

Operating Your Vented Dryer

QUICK START GUIDE

IMPORTANT! Before operating the machine, ensure it has been installed correctly according to the full installation instructions.

DRY CLOTHES PREPARATION

Follow these steps to prepare your dryer for a cycle:

- Plug in the power cord.
- Load the clothes.
- Close the door.

STARTING A DRYING CYCLE

1. Turn on the Power
2. Select a Program
3. Start the machine (Press the start/pause button).

END OF DRYING CYCLE

When the drying process is complete, the machine will provide an audible alert.

Follow these steps after the cycle ends:

- Open the door and take out the clothes.
- *Clean up the filter. (Refer to the Cleaning and Maintenance section for detailed instructions).
- Turn off the power supply.

Tip: If your power outlet has a separate switch, you may turn off the power supply by pressing this switch.

IMPORTANT SAFETY & USAGE ATTENTION

For safe and effective operation, please observe the following points:

- This dryer is designed exclusively for household use. Always set up and use the procedure strictly according to the guidelines in this manual.
- Do not overload the dryer. Excessive clothing may become wedged between the drum and the inspection window seal, potentially causing damage to the machine.
- Do not place dripping wet items into the dryer. This wastes energy and risks damaging the dryer by allowing water to drip onto electrical components, which could lead to a fire hazard.
- Do not dry fabrics containing foam rubber or similar materials (such as sponge-like material).
- Easily damaged fine fabrics (e.g., silk, man-made fabrics, etc.) should not be tumble dried to prevent wrinkling and damage.

Operating Your Vented Dryer (Continued)

PREPARATIONS BEFORE DRYING

Before starting any drying cycle, follow these preparation steps to ensure efficient operation and protect your garments:

GENERAL PREPARATIONS

1. **Clean the filter:** Always clean the inner barrel (drum) and the lint filter before each use to maximise drying efficiency.
2. **Power Supply:** Ensure the machine is correctly connected to the AC power supply.
3. **Clothing Treatment & Sorting:**
 - Sort clothes for drying according to their type: cotton products, chemical fibre fabrics, and wool fabrics.
 - Empty all pockets to prevent damage to the dryer and to avoid unravelling or damage to decorative items during the cycle.
 - **Silk Items:** When drying delicate or scattered silk garments, place them inside a mesh laundry bag and seal the bag before drying.
 - **Large Items:** Big items, such as sheets and tablecloths, should be placed loosely inside the drum. Do not fold them.
 - **Buttons/Zippers:** Fasten buttons and hooks, and close any seams, zippers, and drawstrings to prevent them from catching on other items or the drum.
 - **Turning Garments:** Turn garments with prints, embellishments, or heavy seams (like shirts) inside out.

LOADING THE CLOTHES

1. Open the door.
2. Shake out the clothes to separate them.
3. Place the clothes in the dryer.
4. Finally, close the door firmly.

REFERENCE WEIGHTS OF COMMON CLOTHES

The following table provides reference weights for common dry garments to help prevent overloading the machine:

 Blended Jacket (800g)	 Jacket (800g)
 Jeans (500g)	 Towel Quilt (900g)
 Single Bed Sheet (600g)	 Work Clothes (120g)
 Sleepwear (200g)	 Shirt (300g)
 T-shirt (180g)	 Underwear (70g)
 Socks (30g)	 Baby Clothes (100g)

Operating Your Vented Dryer (Continued)

CONTROL PANEL INTRODUCTION

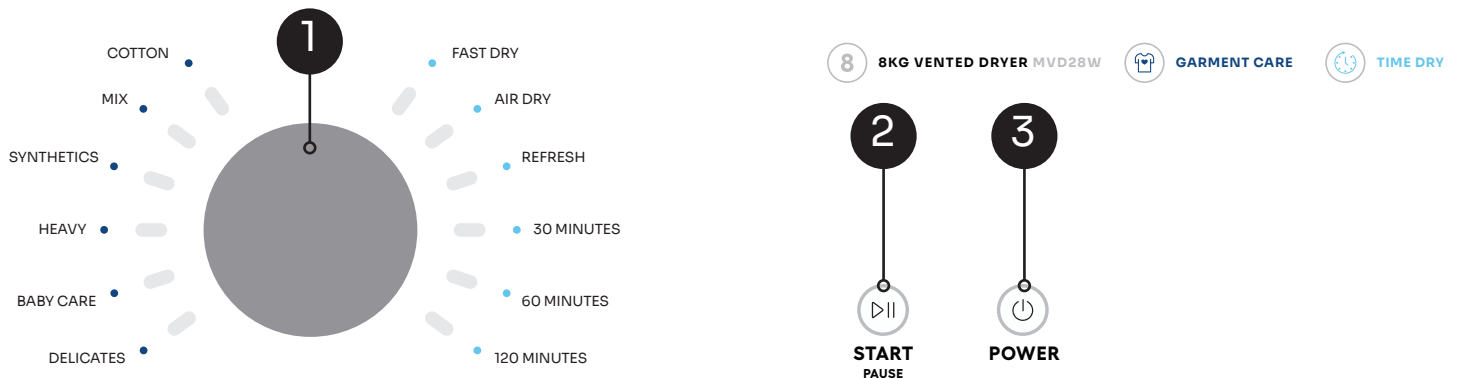

Figure 4 — The control panel for your Vented Dryer

The dryer's control panel consists of three main elements:

Number	Feature	Function
1	Power Button	Press and hold this button for 1 second to turn the machine on or off. The machine will emit a power-on or power-off tone.
2	Start / Pause Button	Used to start or temporarily pause the drying process. Each press will sound a tone and alternate between the start and pause functions. Note: In pause mode, the drying level (Dryness) of the clothes cannot be adjusted.
3	Program Dial	Select one of the 12 available drying programs. When the knob is turned, a prompt sound will be emitted and the corresponding program LED indicator light will illuminate.

ATTENTIONS (IMPORTANT NOTES):

- The operating times and procedures listed above are specific to this machine model and may vary from other dryers.
- The actual drying time will be affected by external factors, including the room temperature, humidity, and the type and weight of the load.
- Always select a program that is appropriate for the clothing's care label requirements.
- The machine will sound a reminder after the drying process is complete to prompt you to remove the clothes promptly.
- For safety reasons, always clean the lint filter and unplug the dryer after each use.

TIP: If the load of clothes to be dried is less than 1kg, it is recommended to use the Fast Dry program.

Operating Your Vented Dryer (Continued)

HOW TO PERFORM A DRYING CYCLE

Follow these five simple steps to successfully complete a drying cycle:

STEP 1: PREPARE THE CLOTHES AND MACHINE

- **Check Power:** Ensure the machine's power cord is securely plugged into the wall socket.
- **Sort and Prepare:** Sort your laundry by fabric type (e.g., cotton, synthetics). Empty all pockets, close zippers and buttons, and turn garments inside out as necessary.
- **Clean Filter:** Always ensure the lint filter is clean before loading the clothes to maintain drying efficiency.
- **Load Clothes:** Open the door, shake out the clothes, place them loosely in the drum, and firmly close the door.

STEP 2: TURN ON THE DRYER

- Press and hold the Power button for one second until you hear the power-on tone. The machine will now be in standby mode.

STEP 3: SELECT THE DRYING PROGRAM

- Turn the Program Knob to select the desired drying cycle.
- As you turn the knob, you will hear a prompt sound, and the corresponding program's LED indicator light will illuminate.
- **Sensor Drying Programs (e.g., Cotton, Heavy):** Select these for sensor-based drying.
- **Fixed-Time Programs (e.g., 30 Minutes, Refresh):** Select these when you need a specific, non-sensor-controlled drying time.

STEP 4: START THE CYCLE

- Press the Start/Pause button once to begin the drying cycle. You will hear a confirmation tone.
- The machine will now begin tumbling and heating.

STEP 5: END OF CYCLE AND UNLOADING

- **Cycle Completion:** When the drying process is finished, the machine will provide an audible reminder.
- **Unload Clothes:** Open the door and immediately remove the dried clothes to minimise wrinkling.
- **Clean Filter:** Once the clothes are removed, clean the filter again to prepare for the next cycle.
- **Power Down:** For safety, press the Power button to turn the machine off, and then unplug the power cord from the wall socket. If the power outlet has a separate switch, turn the power off there.

Operating Your Vented Dryer (Continued)

DRYING PROGRAMS AND OPERATING PARAMETERS

Program	Type	Laundry Recommendation	Dry Time	Cool Time	Dryness Level
Cotton	Sensor Drying	Everyday cotton garments, linens, and durable items.	—	5 Minutes	Standard
Mix	Sensor Drying	Mixed loads of durable fabrics, poly-cottons, and general garments.	—	5 Minutes	Standard
Synthetics	Sensor Drying	Polyamide, acrylic, and polyester items.	—	5 Minutes	Standard
Heavy	Sensor Drying	Towels, linen and thick sheets requiring maximum dryness.	—	5 Minutes	Extra Dry
Baby Care	Sensor Drying	Sensitive baby clothes and children's wear.	—	5 Minutes	Extra Dry
Delicates	Sensor Drying	Lace, lingerie, and heat-sensitive items needing gentle care.	—	5 Minutes	Standard
Fast Dry	Sensor Drying	Small loads (Less than 1kg) needing a quick run.	—	5 Minutes	Standard
Air Dry	Fixed Time	Ventilating items, airing out garments, or removing lint without heat.	30	—	—
Refresh	Fixed Time	Removing minor odours and freshening worn-but-clean garments.	20	5 Minutes	—
30 Minutes	Fixed Time	Custom drying for slightly damp items or small accessories.	30 Minutes	5 Minutes	—
60 Minutes	Fixed Time	Custom drying for moderately damp items.	60 Minutes	5 Minutes	—
120 Minutes	Fixed Time	Custom drying for heavier or denser items that require extended time.	120 Minutes	5 Minutes	—

Notes:

- Sensor Drying: Programs marked 'Sensor Drying' use moisture sensors to detect the load's dryness. Time is an estimate until the sensor level is met.
- Dry Time (min): '-' indicates the time is variable and determined by the sensor.
- Dryness Level: 'Standard' is ready for ironing or folding; 'Extra Dry' is extra dry.

Cleaning and Maintenance

By ensuring proper cleaning and maintenance of your Vented Dryer, you can ensure that it will have a long and fault free operation.

WARNING! To avoid an electric shock, always unplug your dryer before cleaning.

CLEAN AFTER EVERY USE:

- Lint build-up on the filter mesh will slow down air circulation and increase the drying time.
- **WARNING! FIRE DANGER:** Failure to clean the filter after every use allows flammable lint to accumulate, creating a serious fire hazard.
- The filter must be cleaned after every single use to ensure efficiency and safety.

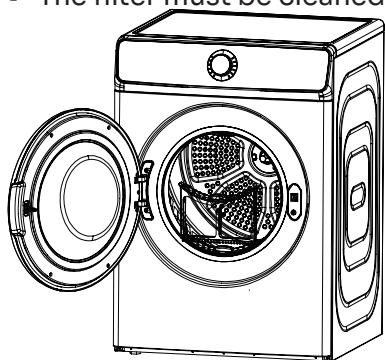

CLEANING THE FILTER

- **CAUTION!** Always unplug the appliance or switch it off at the wall socket before you start cleaning.
- Open the dryer door and remove the filter, located within the door opening (refer to Figure 1 within this manual).
- Gently remove the lint (or ‘fluff’) from the filter mesh. You can use a damp, well-wrung cloth or simply use your hands.
- Washing the Filter (If Necessary): If you’ve used a fabric softener, a waxy residue might build up on the filter. If this happens: Remove the filter and wash it in warm, soapy water and rinse it thoroughly.

INSTALLING THE FILTER:

- If you’ve cleaned the filter with a damp cloth or washed it in water, it must be completely dry before you put it back into the dryer.
- Once dry, insert the filter back into the dryer door opening.
- **IMPORTANT!** When cleaning, do not press hard on the mesh or ‘screen’ of the filter, as this can easily damage it.
- Once dry, re-fit the lint filter into the door opening.

IMPORTANT! Clean the filter after each use and must be installed while in use.

CLEANING THE INNER DRUM

Cleaning the Surfaces:

- Use a soft damp cloth to wipe the inner drum and cabinet.
- Ensure that the cloth is only slightly damp and never use excessive amounts of water.
- Do not use scouring pads or other abrasives as these will cause damage to your dryer.
- Do not use alcohol wipes or harsh cleaning chemicals..
- Use a mild, neutral detergent for cleaning.
- Do not rinse the dryer directly with water.
- Do not use volatile materials like thinner, petrol (gasoline), or alcohol for cleaning, as these can damage the surfaces.

IMPORTANT! After cleaning the interior drum, leave the dryer door open to allow the drum to dry completely.

Troubleshooting

BASIC TROUBLESHOOTING

Check the points listed here before you call for help, and make sure that you have followed the Important safety Instructions within this manual.

Problem	Possible causes & Explanation	Action to Take
Fabrics Are Not Drying	Power Interruption: The cycle stopped due to a brief power failure.	Restart the dryer cycle.
	Blocked Airflow: The air outlet at the back of the dryer is blocked by lint build-up or foreign objects.	Check the air outlet at the back of the dryer for blockages and clean it thoroughly.
	Blocked Filter: The lint filter is full.	Check the filter for blockage and clean it immediately.
	Item Entanglement: When drying large items (sheets, quilt covers, tablecloths), clothes may become excessively tangled during rotation.	The machine may need to be repeatedly shaken and dried. Unload the items, untangle them, and restart the cycle.
	Heavy Layers: Dense items (denim, thick coat) retain moisture in partial layers even after a standard program finishes.	The partial layers that are not thoroughly dry can be dried again using the appropriate fixed-time program (e.g., 30 Minutes).
Possible Sounds When Dryer is Running	Drum Vibrating Sound: Usually caused by the wet weight of clothing impacting the wall of the drum as it rotates.	This is generally normal if the load is damp. Ensure the dryer is on a level surface.
	Airflow Impingement Sound: This sound occurs as water vapour is discharged from the exhaust pipe, and the vapour impacts the rotating inner drum.	This is a normal phenomenon when the dryer is working.
	Clothing Collision Sound: Items with metal components (zips, buttons, buckles) impact the inner drum or viewing window.	This is normal. To reduce noise, ensure these items are turned inside out before drying.
Significant Increase in Room Temperature	Poor Ventilation: The room is not adequately ventilated.	Ensure the area has proper ventilation.
	Blocked Rear Airflow: The air outlet at the back of the dryer is blocked.	Remove the obstacle blocking the air outlet.
Dryer Does Not Start	Start Button Not Pressed: The program has been selected but the start button has not been pressed.	Press the Start button.
	Door Open: The dryer door is not firmly closed.	Ensure the door is securely closed.
Start Indicator is Not Lit	Power Supply Issue: The power plug is loose or has not been fully plugged into the wall socket.	Check and securely insert the power plug.
	Dryer Switch Off: The main dryer power switch (or the wall switch) is not turned on.	Ensure the dryer switch button is set to the ON position.
Over Dry	Incorrect Time Selection: The selected program had an excessively long drying time for the load size.	Select a program with a shorter drying time or use an Intelligent program.

Troubleshooting (Continued)

IMPORTANT! To operate all vented clothes dryers efficiently, the clothes dryer must have an unrestricted air supply and exhaust ventilation. Service calls resulting from installation where ventilation is restricted are not covered by warranty. The cost of this type of service call will be charged to the customer. Should you require further instructions in the use and care of your clothes dryer please contact your local Customer Care team.

POSSIBLE FAILURES

Certain problems are due to lack of simple maintenance or oversights, which can be solved easily without calling out a service technician. Before contacting your local Customer Care team, please check possible cause of malfunction and solution listed below. Once the problem has been eliminated, press the Start/Pause button to restart the program. If after all checks, the problem persists, contact your local Customer Care team.

FAILURE INDICATION	DESCRIPTION
Four corner LED lights flashing	Communication failure of the power supply board/display board.
Left half circle LED flashing	Temperature sensor abnormal.
Right half circle LED flashing	Over temperature warning.
ALL LED flashing	Door warning (The door is not closed properly).

ACCESSORIES, PARTS OR FURTHER SUPPORT

Should you need to purchase a replacement lint filter, or any other spare parts, please contact our local Customer Care team, details of which can be found below.

- Email: support@residentiagroup.com.au
- Phone: 1300 11 4357

Technical Specifications

Below outlines the technical specifications for your Vented Dryer.

Model/s	MVD28B, MVD28W
Size	595W × 560D × 845H (mm)
Rated Capacity	8.0kg
Rated Voltage	220–240V~
Rated Frequency	50Hz
Rated Current	7.4A
Rated Power	1700W
Energy Rating (MEPS)	2 Stars
Energy Consumption	351 kWh per Year
Net Weight	33kg
Grade of Waterproof	IPX4

Note:

- This product is subject to continuous improvement, specification are subject to change without prior notice.
- The rated capacity is the maximum capacity to be dried at one time. Make sure that the dry clothes which are loaded into the appliance do not exceed the rated capacity.
- Do not install the tumble dryer in a room when there is a risk of frost occurring. At temperatures around freezing point the tumble dryer may not be able to operate properly.
- There is a risk of damage if the condensate water is allowed to freeze in the pump, hoses and / or condensate water container
- This product was tested in accordance with AS/NZS 2442.1 and AS/NZS 2442.2 using the program: Cotton, which is the program recommended for drying a normally soiled cotton load at the rated capacity.

**Attach your receipt
to this page**



Purchase Details

For future reference, please record the following information which can be found on the rating plate and the date of purchase which can be found on your sales invoice.

STORE DETAILS

STORE NAME | _____

ADDRESS | _____

TELEPHONE | _____

PURCHASE DATE | _____

PRODUCT DETAILS

MODEL NO. | _____

SERIAL NO. | _____

Warranty Information

AUSTRALIAN WARRANTY TERMS AND CONDITIONS

VENTED DRYERS

This document sets out the terms and conditions of the product warranties for Residentia Group Appliances. It is an important document. Please keep it with your proof of purchase documents in a safe place for future reference should you require service for your Appliance.

1. **In this warranty**
 - (a) 'acceptable quality' as referred to in clause 10 of this warranty has the same meaning referred to in the ACL;
 - (b) 'ACL' means Trade Practices Amendment (Australian Consumer Law) Act (No.2) 2010;
 - (c) 'Appliance' means any Residentia Group product purchased by you accompanied by this document;
 - (d) 'ASR' means Residentia Group authorised service representative;
 - (e) 'Residentia Group' means Residentia Group Pty Ltd of 165 Barkly Ave, Burnley VIC 3121, ACN 70 600 546 656 in respect of Appliances purchased in Australia;
 - (f) 'major failure' as referred to in clause 10 of this warranty has the same meaning referred to in the ACL and includes a situation when an Appliance cannot be repaired or it is uneconomic for Residentia Group, at its discretion, to repair an Appliance during the Warranty Period;
 - (g) 'Warranty Period' means:
 - (i) where the Appliance is used for personal, domestic or household use (i.e. normal single family use) as set out in the instruction manual, the Appliance is warranted against manufacturing defects for 24 months, following the date of original purchase of the Appliance;
 - (h) 'you' means the purchaser of the Appliance not having purchased the Appliance for re-sale, and 'your' has a corresponding meaning.
2. This warranty only applies to Appliances purchased and used in Australia and is in addition to (and does not exclude, restrict, or modify in any way) any non-excludable statutory warranties in Australia.
3. During the Warranty Period Residentia Group or its ASR will, at no extra charge if your Appliance is readily accessible for service, without special equipment and subject to these terms and conditions, repair or replace any parts which it considers to be defective. Residentia Group or its ASR may use remanufactured parts to repair your Appliance. You agree that any replaced Appliances or parts become the property of Residentia Group. This warranty does not apply to light globes, batteries, seals, filters or similar perishable parts.
4. Parts and Appliances not supplied by Residentia Group are not covered by this warranty.
5. You will bear the cost of transportation, travel and delivery of the Appliance to and from Residentia Group or its ASR. If you reside outside of the service area, you will bear the cost of:
 - (a) travel of an authorised representative;
 - (b) transportation and delivery of the Appliance to and from Residentia Group or its ASR, in all instances, unless the Appliance is transported by Residentia Group or its ASR, the Appliance is transported at the owner's cost and risk while in transit to and from Residentia Group or its ASR.
6. Proof of purchase is required before you can make a claim under this warranty.

Warranty Information (Continued)

7. You may not make a claim under this warranty unless the defect claimed is due to faulty or defective parts or workmanship. Residentia Group is not liable in the following situations (which are not exhaustive):
 - (a) the Appliance is damaged by:
 - (i) accident
 - (ii) misuse or abuse, including failure to properly maintain or service
 - (iii) normal wear and tear
 - (iv) power surges, electrical storm damage or incorrect power supply
 - (v) incomplete or improper installation
 - (vi) incorrect, improper or inappropriate operation
 - (vii) insect or vermin infestation
 - (viii) failure to comply with any additional instructions supplied with the Appliance;
 - (b) the Appliance is modified without authority from Residentia Group in writing;
 - (c) the Appliance's serial number or warranty seal has been removed or defaced;
 - (d) the Appliance was serviced or repaired by anyone other than Residentia Group, an authorised repairer or ASR.
8. This warranty, the contract to which it relates and the relationship between you and Residentia Group are governed by the law applicable where the Appliance was purchased.
9. To the extent permitted by law, Residentia Group excludes all warranties and liabilities (other than as contained in this document) including liability for any loss or damage whether direct or indirect arising from your purchase, use or non use of the Appliance.
10. For Appliances and services provided by Residentia Group in Australia, the Appliances come with a guarantee by Residentia Group that cannot be excluded under the Australian Consumer Law. You are entitled to a replacement or refund for a major failure and for compensation for any other reasonably foreseeable loss or damage. You are also entitled to have the Appliance repaired or replaced if the Appliance fails to be of acceptable quality and the failure does not amount to a major failure. The benefits to you given by this warranty are in addition to your other rights and remedies under a law in relation to the Appliances or services to which the warranty relates.
11. At all times during the Warranty Period, Residentia Group shall, at its discretion, determine whether repair, replacement or refund will apply if an Appliance has a valid warranty claim applicable to it.
12. Missing parts are not covered by warranty. Residentia Group reserves the right to assess each request for missing parts in a case by case basis. Any parts that are not reported missing in the first week after purchase will not provide free of charge.
13. To enquire about claiming under this warranty, please follow these steps:
 - (a) carefully check the operating instructions, user manual and the terms of this warranty;
 - (b) have the model and serial number of the Appliance available;
 - (c) have the proof of purchase (e.g. an invoice) available;
 - (d) telephone the numbers shown below.
14. You accept that if you make a warranty claim, Residentia Group and its ASR may exchange information in relation to you, in order to enable Residentia Group to meet its obligations under this warranty.

IMPORTANT

Before calling for service, please ensure that the steps in point 13 have been followed.

Contact Service: Please call 1300 11 HELP (4357)

The Australian Consumer Law requires the inclusion of the following statement with this warranty:

Our goods come with guarantees that cannot be excluded under the Australian Consumer Law. You are entitled to a replacement or refund for a major failure and for compensation for any other reasonably foreseeable loss or damage. You are also entitled to have the goods repaired or replaced if the goods fail to be of acceptable quality and the failure does not amount to a major failure.



E2447

myk1n

part of the family