



Model Code: W12-340

Included Accessories

		
6020/OFLOW4		

Optional Accessories

		
CBR420A	FSCO	ICC12
		
UMG	CUdT	

Dimensions

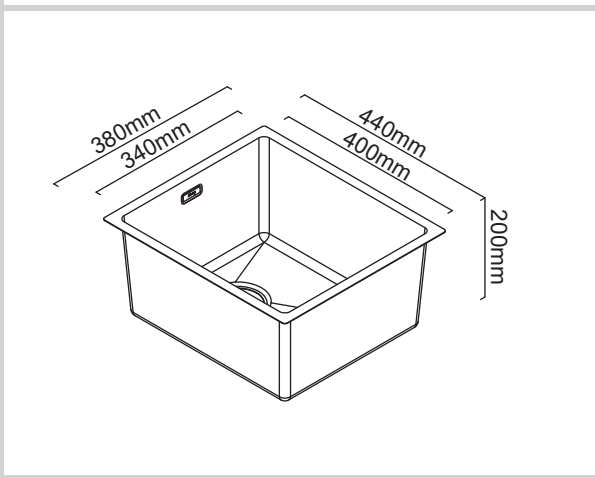

Specifications

Description	Sink, Stainless Steel, Single Bowl
Overall Sink Size	380mm x 440mm x 200mm deep
Bowl Dimensions	340mm x 400mm x 200mm deep
Drainer Length	N/A
Technic	Fabrication
Material	1.0mm Stainless steel SUS304

Installation



Fixings	N/A
Template	N/A
Min Cabinet Size	500mm
Waste Holes	1 x 90mm round Compatible with waste disposal



Plumbing

Waste Fittings	1 x (90mm x 2") basket waste included
Overflow	Included

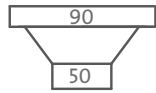
Packaging

Carton Type	EPS protection & individual carton
Gross Weight	4.1Kg
Carton Size	430mm x 495mm x 240mm
Pack QTY	1

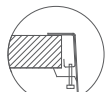
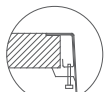
SURFACE FINISH  Microbrush	WASTE KIT  90 50	MATERIAL  SUS 304 Stainless Steel
--	---	---

INSTALLATION OPTIONS  Undermount	 Inset	 Flush-mount	PROFILE  R12.5 Horiz	 R12.5 Vertic
--	--	--	---	--

Abey are Australia's leader in sinkware, designing and manufacturing to the world's highest quality specifications as well as sourcing and bringing you Europe's very best, leading edge designs – practical, affordable, inspirational, stylish, timeless or cutting edge. When you buy an Abey stainless steel sink you receive the highest quality and a 25 year warranty. Abey and the manufacturer are continually seeking ways to improve the design specifications, aesthetic and production techniques of the products. As a result, alterations to the specifications and dimensions of the products and design occur continually.