

BILLI HOME DATA SHEET - B-5000

Billi™

Instant boiling and chilled filtered water available any time of the day or night. The most popular model in the Billi Home range, the Billi B-5000 is ideal for typical family use. The B-5000 is space saving, energy efficient and elegant. The functional style is designed for convenience in your home.



Features and Benefits

- Adjustable Chilled water temperature 6°C - 15°C
- Space saving design fits easily within a standard cupboard
- Choice of Dispenser design and finish
- Childproof Safety Switch
- Splashfree Delivery
- Standby mode to conserve power
- Heat reclaim recovers waste heat energy from the chilling process to pre heat the boiling water
- Eco Intelligence self learning timer to learn user behaviour and save energy during quiet periods
- No Ventilation Grille required
- Australian Designed and Made

Compatible Dispensers

XL Levered

XL

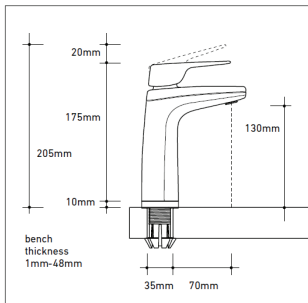

Finishes

CH - Chrome	BR - Brushed
MB - Matte Black	MW - Matte White

Special Finishes

RG - Rose Gold	UB - Urban Brass
GB - Gloss Black	PL - Platinum
FB - Florentine Bronze	BRG - Brushed Rose Gold
GM - Gun Metal Grey	

XT Touch

XT

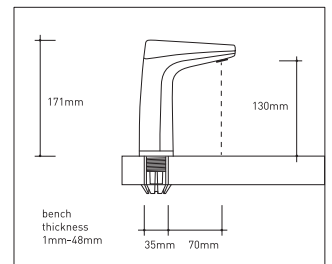

Finishes

CH - Chrome	BR - Brushed
MB - Matte Black	MW - Matte White

Accessories

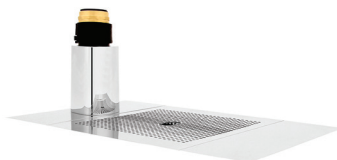

70mm Riser & Font
992800



120mm Riser & Font
992803



BILLI B-5000 PRODUCT SPECIFICATIONS

Product feature	Product code	Model name	Dispenser	Boiling water delivery (cups per hour)	Chilled water delivery (cups per hour)	Power supply (amps)	HxWxD (mm)
 	915000L	B-5000	XL Levered	60	60	10	340x180x500
	915000T	B-5000	XT Touch	60	60	10	340x180x500

For all underbench filtered water systems, consideration may be needed for usage patterns and draw-off methods. Based on the initial number of cups of boiling water immediately available, drawn one cup every 10 seconds. 1 cup = 170ml.

TECHNICAL DRAWING & INSTALLATION REQUIREMENTS

WATER SUPPLY

A single 1/2" BSP (15mm) stop-tap with a male thread should be installed in an easily accessible position. Water supply must be microbiologically safe to drink, with a minimum dynamic water pressure of 250kPa to a maximum of 1000kPa.

POWER SUPPLY

A standard 10 amp power outlet is required in the cupboard where the unit is to be installed. The unit is supplied with a 1 metre flex cord and plug.

FILTRATION

Billi's range of premium filters utilise BWT's unique Fibron X technology. Billi's filter range provides superior water quality, consistent filter life and peace of mind.

Billi recommends the B-5000 for use with our 0.2 Micron (994052) or 5 Micron (994051) replacement filters for the highest quality drinking water.

CERTIFICATIONS

Every Billi drinking water appliance is manufactured under a certified quality control system. All Billi home range models have been tested and comply with all required standards including: Watermark License Number 21525; Tested to AS/NZS4020; RCM approved. This appliance complies with current safety requirements. Quality Management System complies with the requirements of ISO 9001:2015, Certificate No. QEC11627.

WARRANTY

The Billi B-5000 range is covered by a comprehensive 2 Year Warranty on all parts and labour.

PREFERRED INSTALLATION LAYOUT

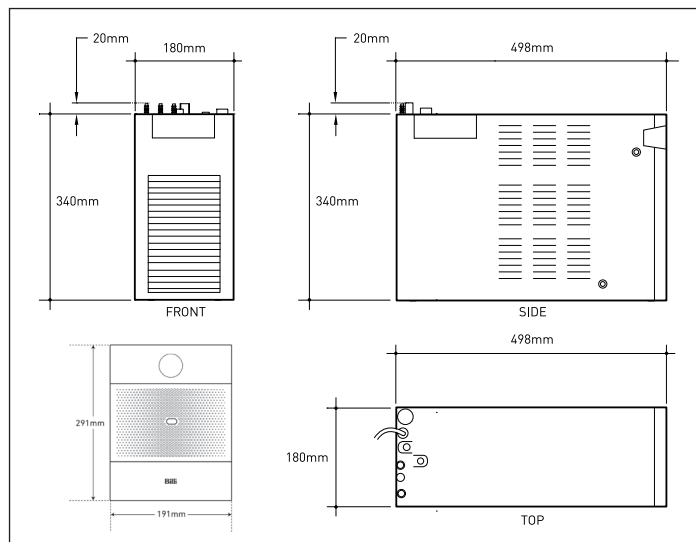
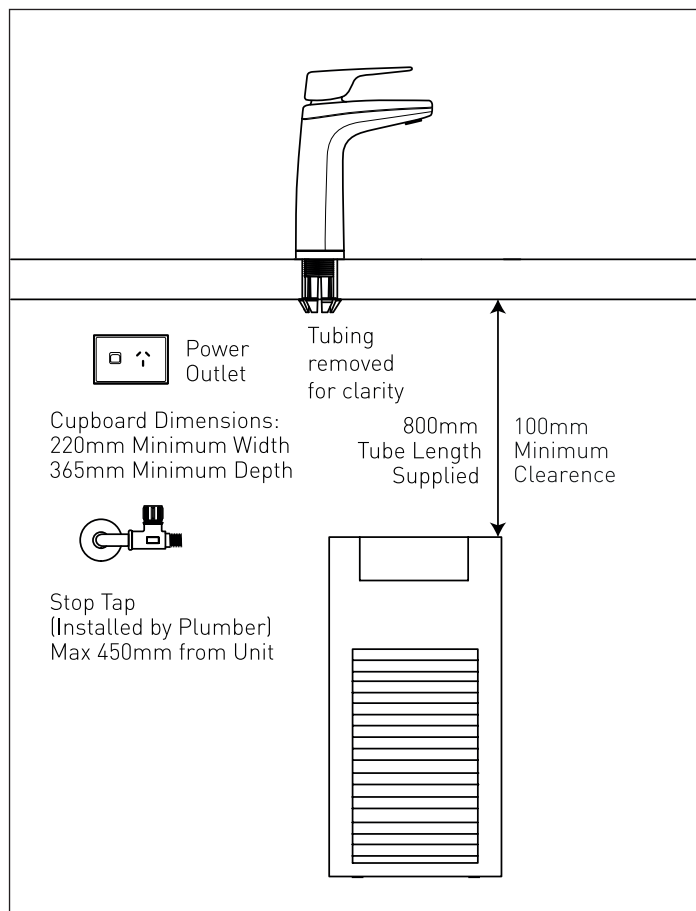

Billi™



Designed and manufactured in  Australia to the highest quality standards

Billi Australia Pty Ltd
42 Lucknow Crescent,
Thomastown, Victoria
3074 Australia

P 1800 812 321
F +61 3 9469 0499
W www.billi.com.au

visit us at

