



Model Code: W50-180

Included Accessories

		
LB-9134	ICE10	

Optional Accessories

		
DR006	UMD	DTA30
		
CBB282	6020	

Dimensions

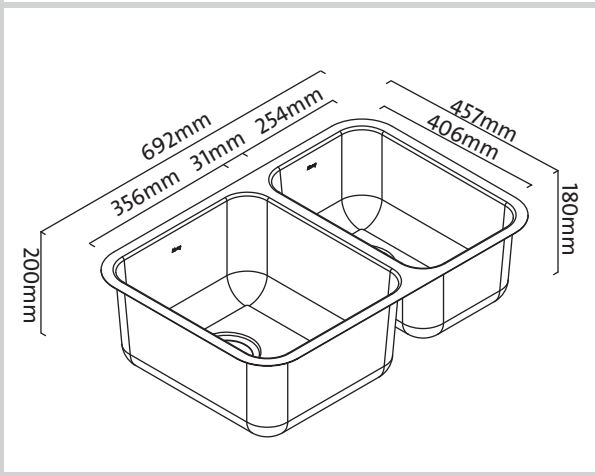

Specifications

Description	Sink, Stainless Steel, Single Bowl
Overall Sink Size	692mm x 457mm x 200mm deep
Bowl Dimensions	356mm x 406mm x 200mm deep 254mm x 406mm x 180mm deep
Drainer Length	N/A
Technic	Pressed
Material	1.1mm Stainless steel SUS304

Installation

Fixings	Inset clips supplied
Template	N/A
Min Cabinet Size	800mm
Waste Holes	1 x 90mm round Compatible with waste disposal

Plumbing

Waste Fittings	1 x (90mm x 2") basket waste included
----------------	---------------------------------------

Packaging

Carton Type	EPS protection & individual carton
Gross Weight	5.1Kg
Carton Size	725mm x 490mm x 230mm
Pack QTY	1

SURFACE FINISH



WASTE KIT

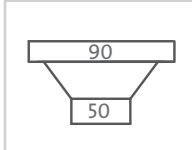

MATERIAL



INSTALLATION OPTIONS

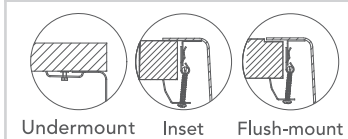

PROFILE

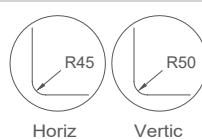

Abey are Australia's leader in sinkware, designing and manufacturing to the world's highest quality specifications as well as sourcing and bringing you Europe's very best, leading edge designs – practical, affordable, inspirational, stylish, timeless or cutting edge. When you buy an Abey stainless steel sink you receive the highest quality and a 25 year warranty. Abey and the manufacturer are continually seeking ways to improve the design specifications, aesthetic and production techniques of the products. As a result, alterations to the specifications and dimensions of the products and design occur continually.